

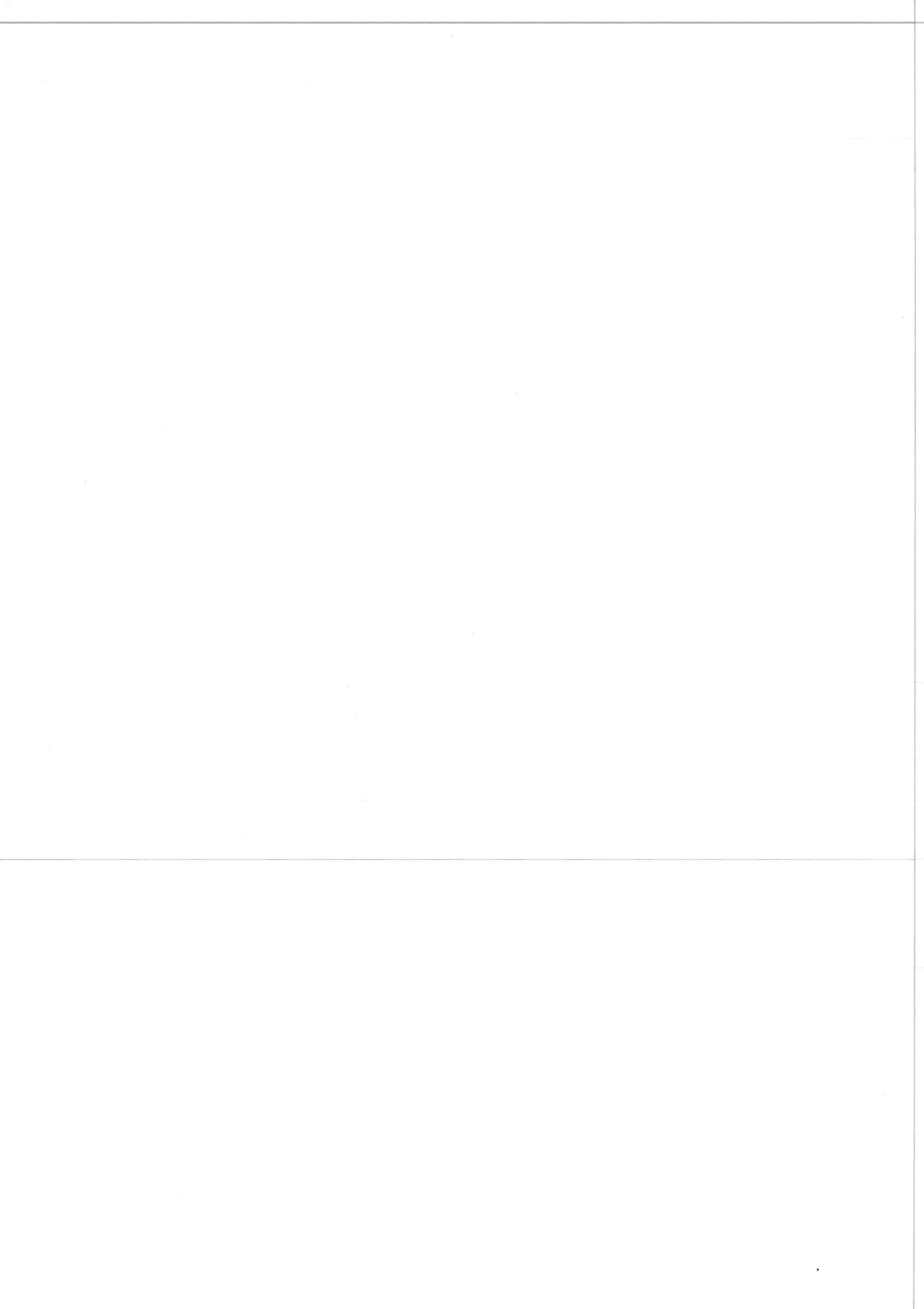

# Handicare 1100 User Manual

Manual Style seat  
Powered Style seat



## CONTENT

<b>USER MANUAL</b>	<b>1</b>
<b>OPTIONS</b>	<b>10</b>
<b>IMPORTANT INFORMATION</b>	<b>14</b>
<b>FAULT FINDING</b>	<b>18</b>
<b>ATTACHMENTS</b>	<b>23</b>
A. Reminders	23
B. Emergency operation	24
C. Diagnostic codes	26

## FOREWORD

Thank you for choosing a Handicare stairlift. This manual is for the HANDICARE 1100 lift type, and includes instructions for the standard features and optional upgrades.

**Make everyday life easier...**

# STYLE SEAT

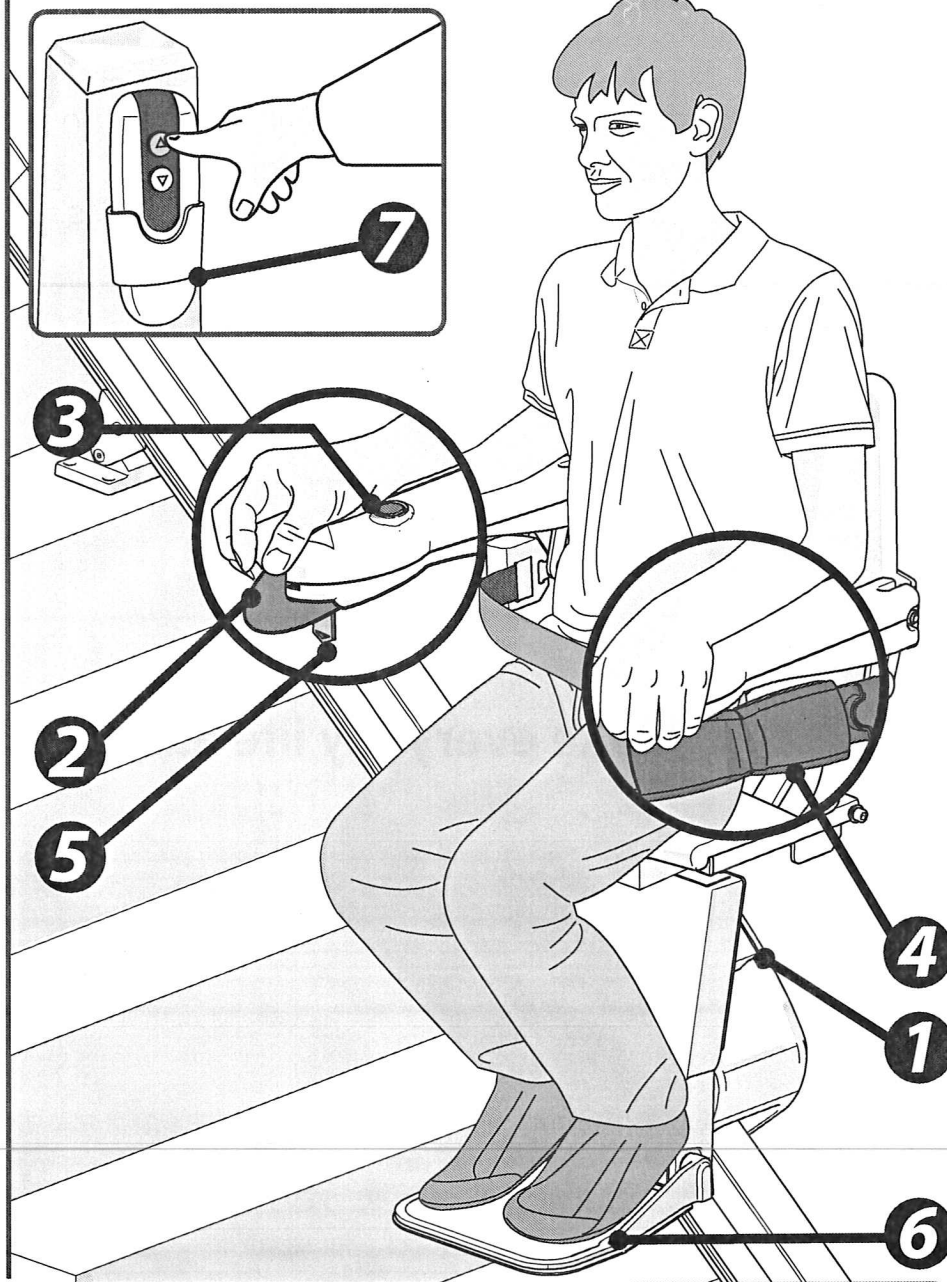

## OPTIONS

Powered Swivel

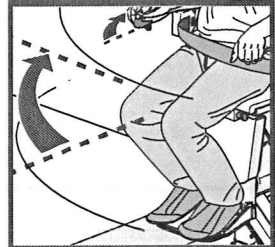

Powered Footrest

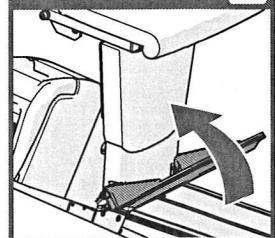

Easy hinge  
(manual)

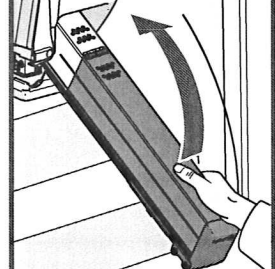

Slide track

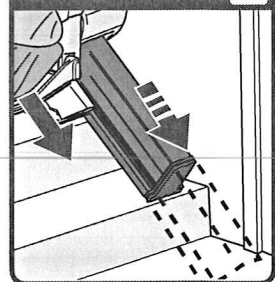

The illustration above shows the features used to operate the STYLE seat. The STYLE seat can be upgraded with the Powered Swivel seat, the Powered Footrest, Easy hinge and the Slide Track, options to create even more seat comfort and user-friendliness.

- [1] Diagnostic Display
- [2] Joystick
- [3] Stop button
- [4] Seat belt
- [5] Key switch
- [6] Footplate
- [7] Remote control

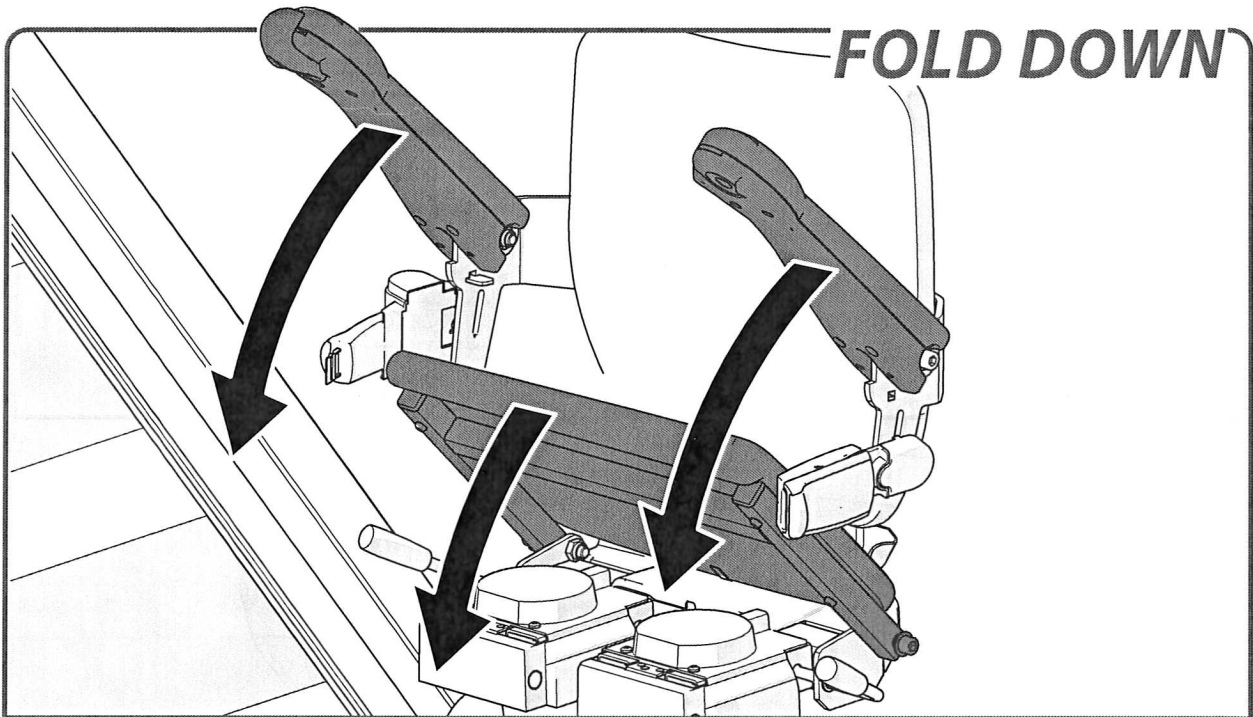

Fold down the armrests and seat.



Sit down on the seat.

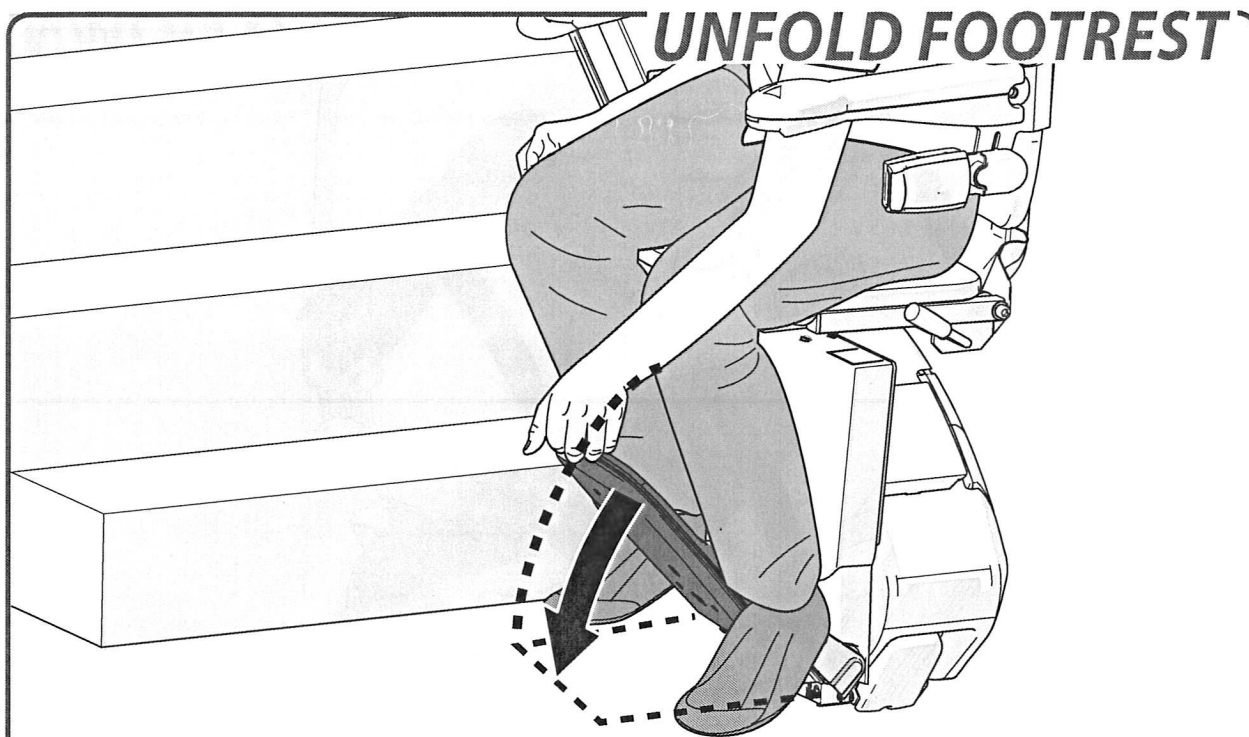

Fold down the footplate.

 [page 11 > OPTIONAL POWERED FOOTREST](#)

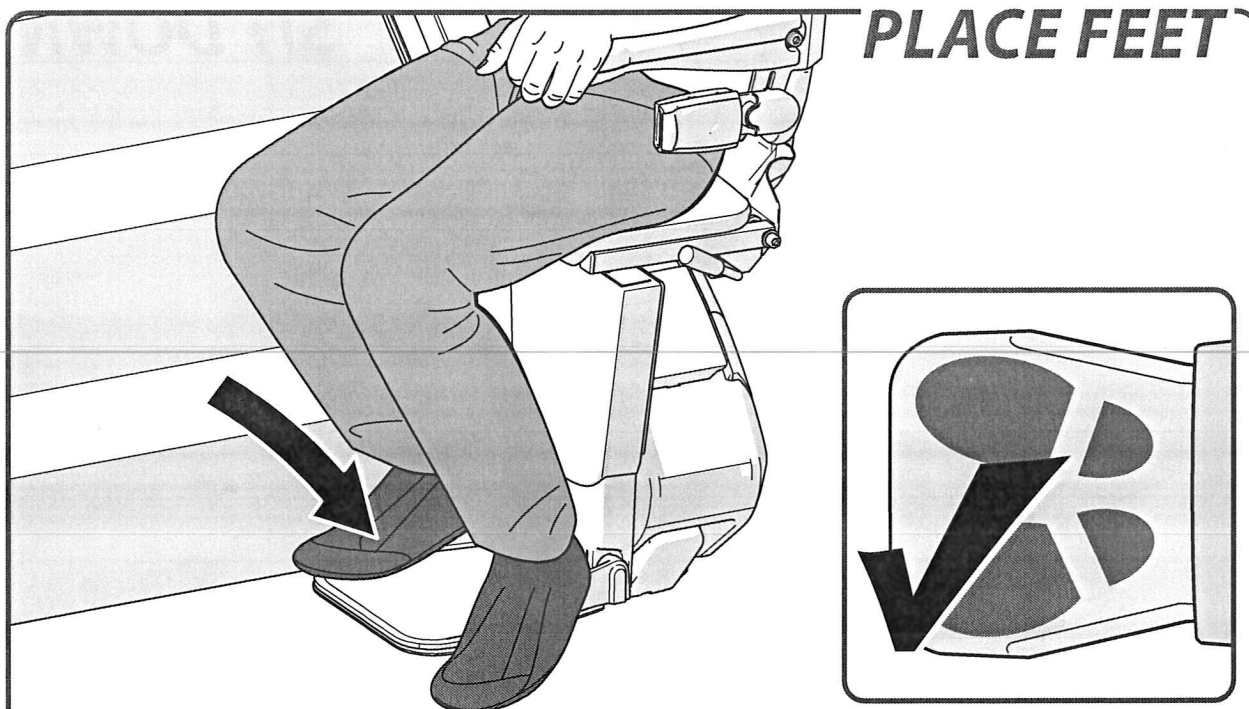

Place your feet on the footplate. Ensure that both feet are completely on the plate.



Fasten the seat belt securely, ensuring that it clicks into the holder. Put the key in the switch and turn it ninety degrees clockwise. Check that the chair is in the locked position.

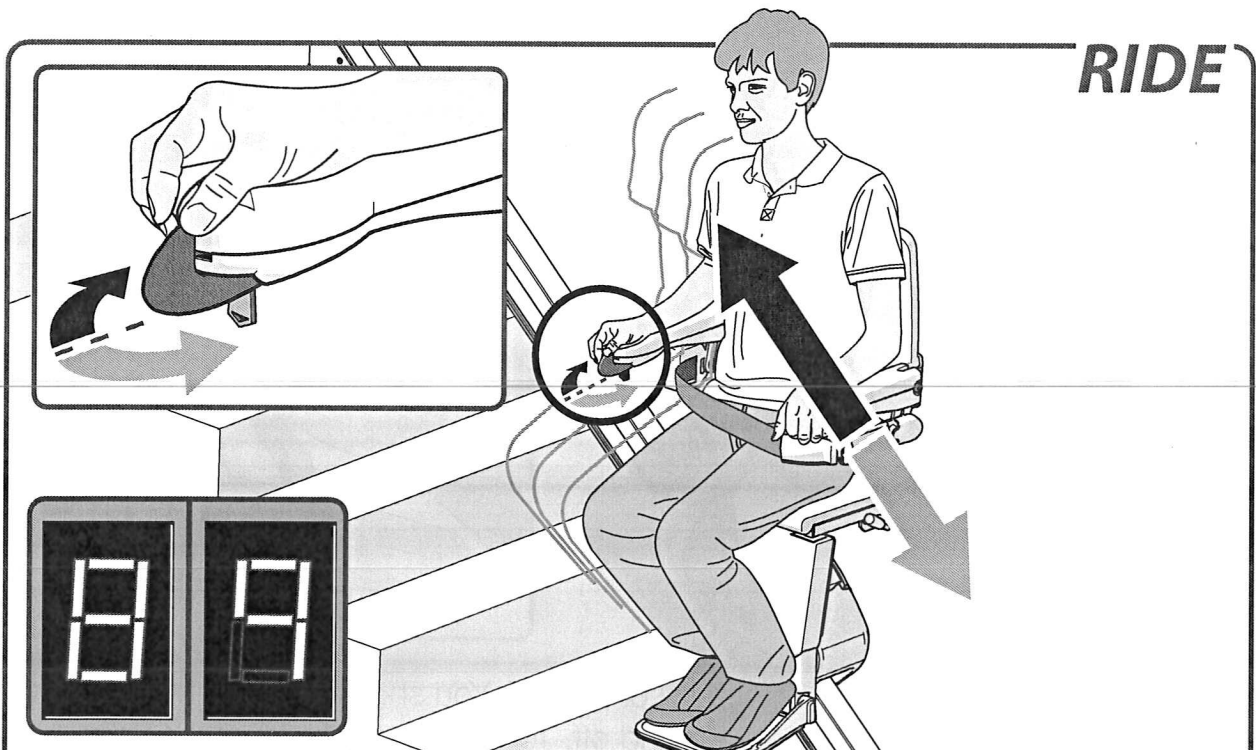

Move and hold the joystick in the desired direction of travel. The display shows a "8/9", the lift gradually starts to move.

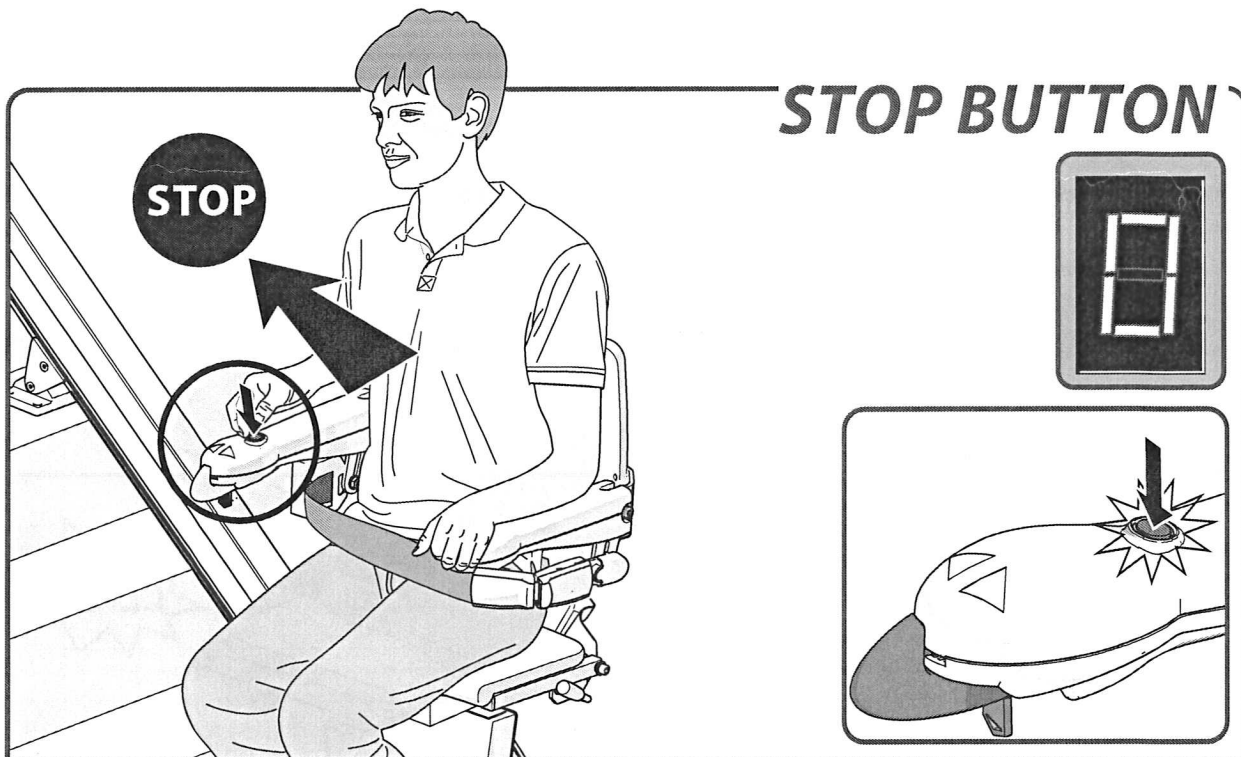

## STOP BUTTON

In an emergency, press the stop button once. The lift stops straight away. To release the lift, press the stop button again.

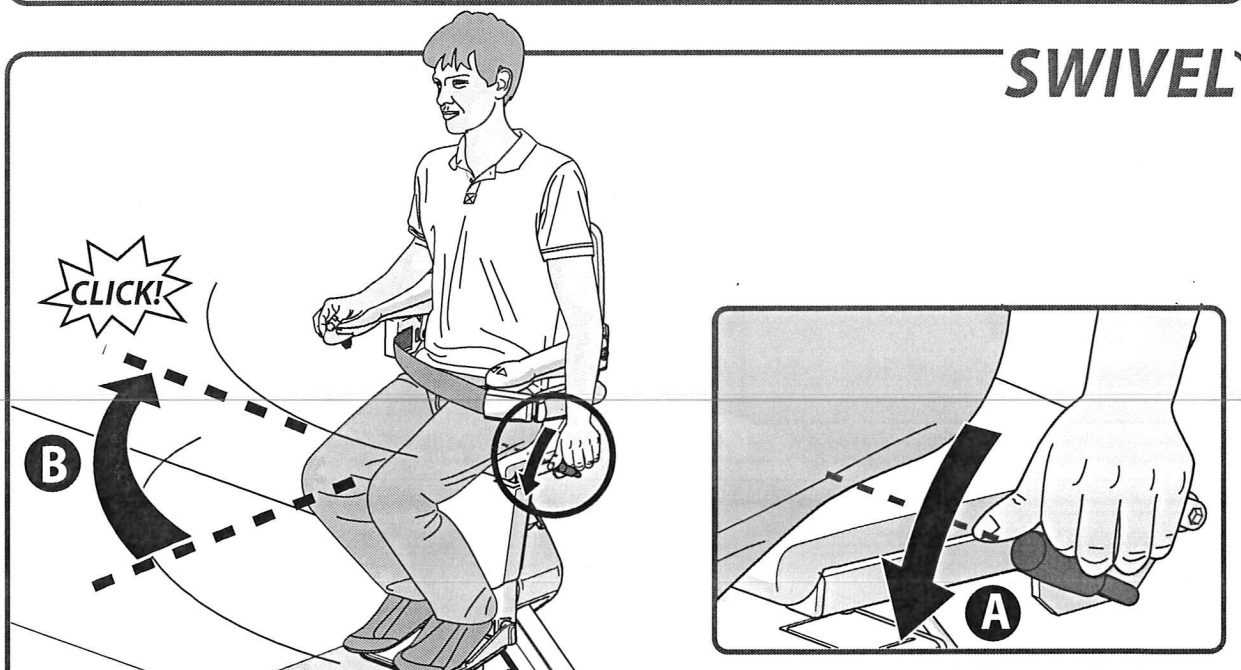

## SWIVEL

The lift stops automatically at the end of the rail. You should now swivel the seat manually, making it easier to get on and off. To do this, push down the lever {A}. Swivel the seat until you hear a 'click'. The seat is now in the correct position {B}.



page 10 > OPTIONAL POWERED SWIVEL

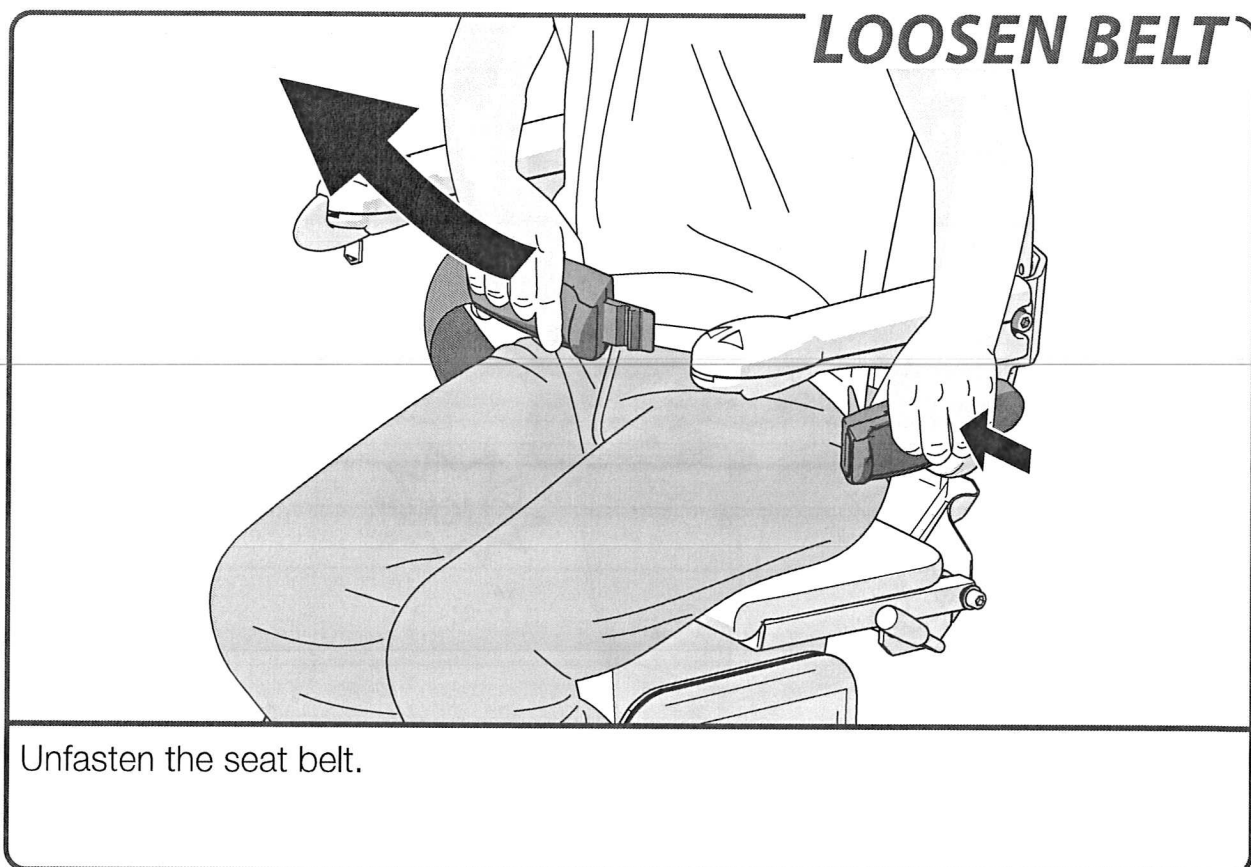
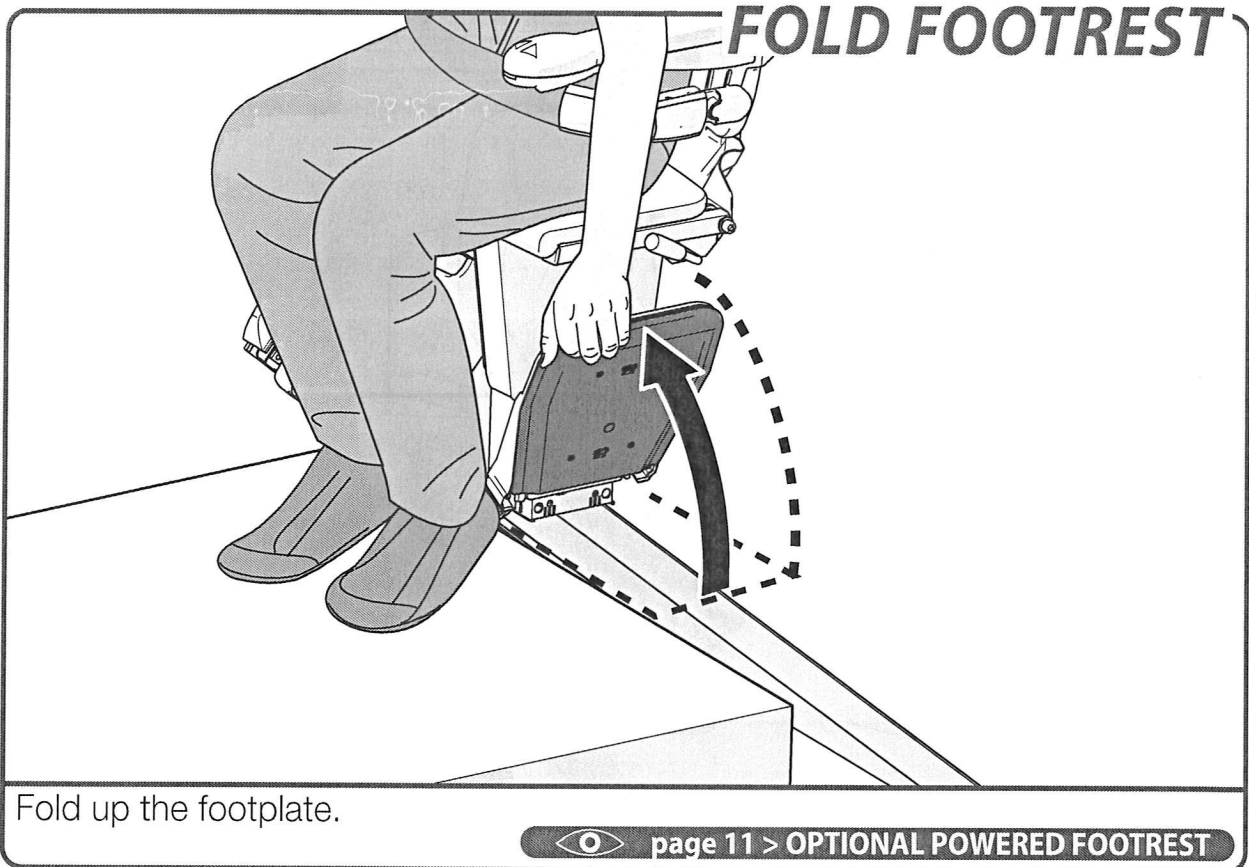

**STAND UP**

Stand up from the seat.

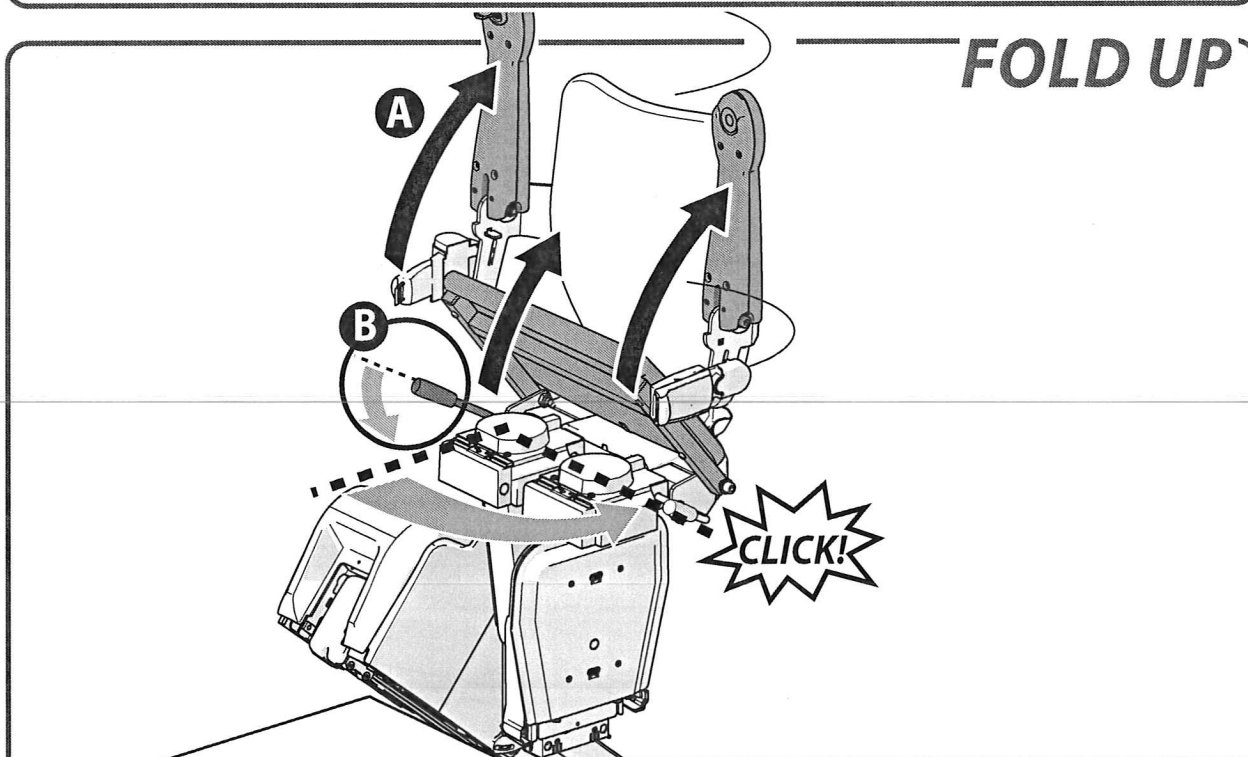
**FOLD UP**

Fold up the armrests and seat {A}. Push the handle, located to the left or right under the seat, downwards {B}. Swivel the seat until you hear a 'click'. The seat is now in the locked position.

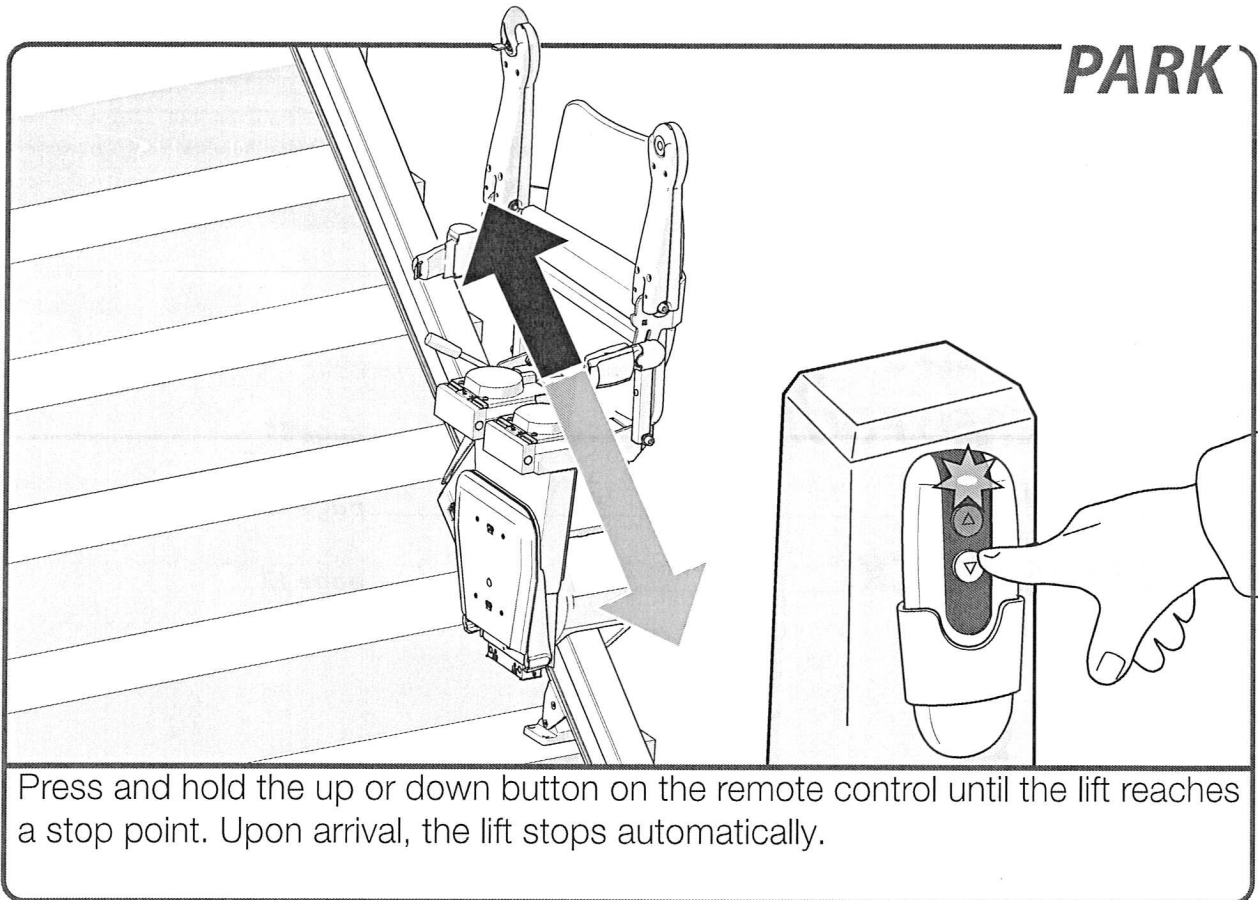

## OPTIONS

**POWERED SWIVEL** \_\_\_\_\_ *page 10*

**POWERED FOOTREST** \_\_\_\_\_ *page 11*

**EASY HINGE** \_\_\_\_\_ *page 12*

**SLIDE TRACK** \_\_\_\_\_ *page 13*

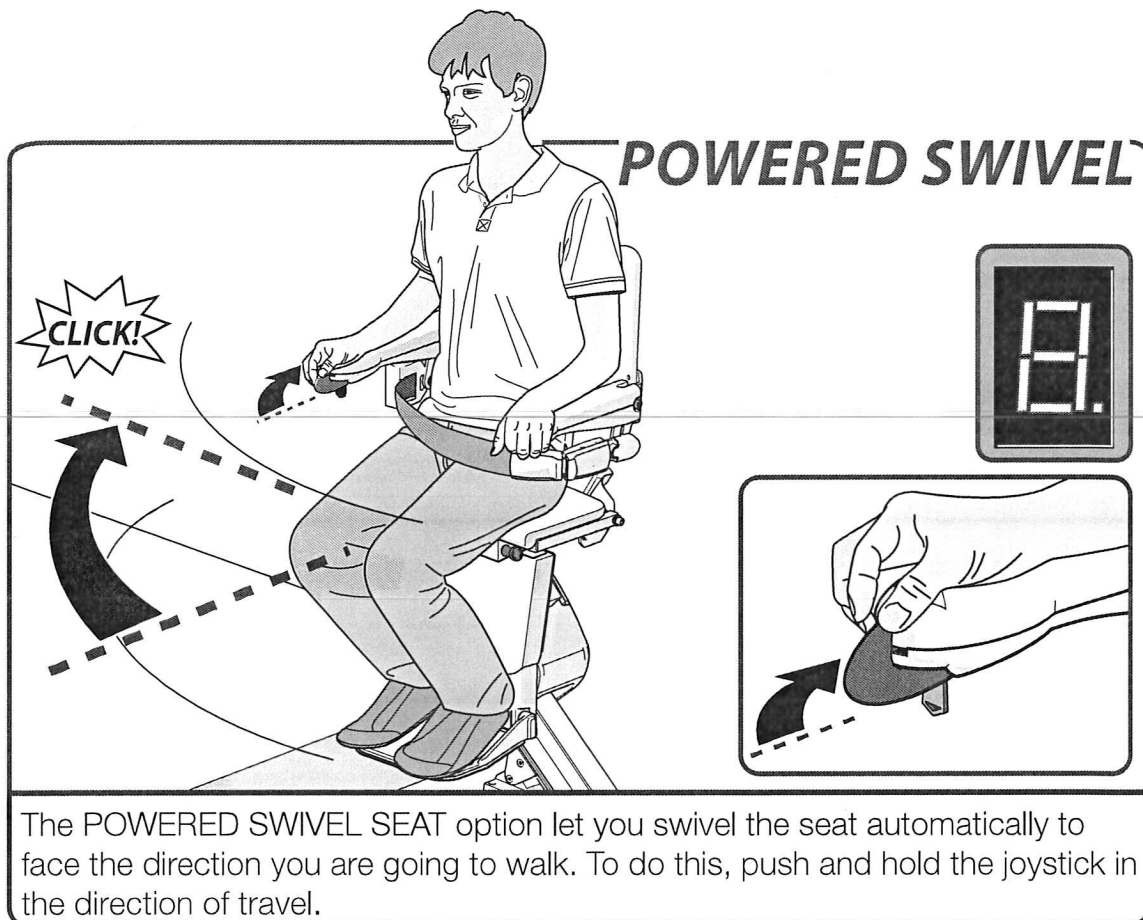

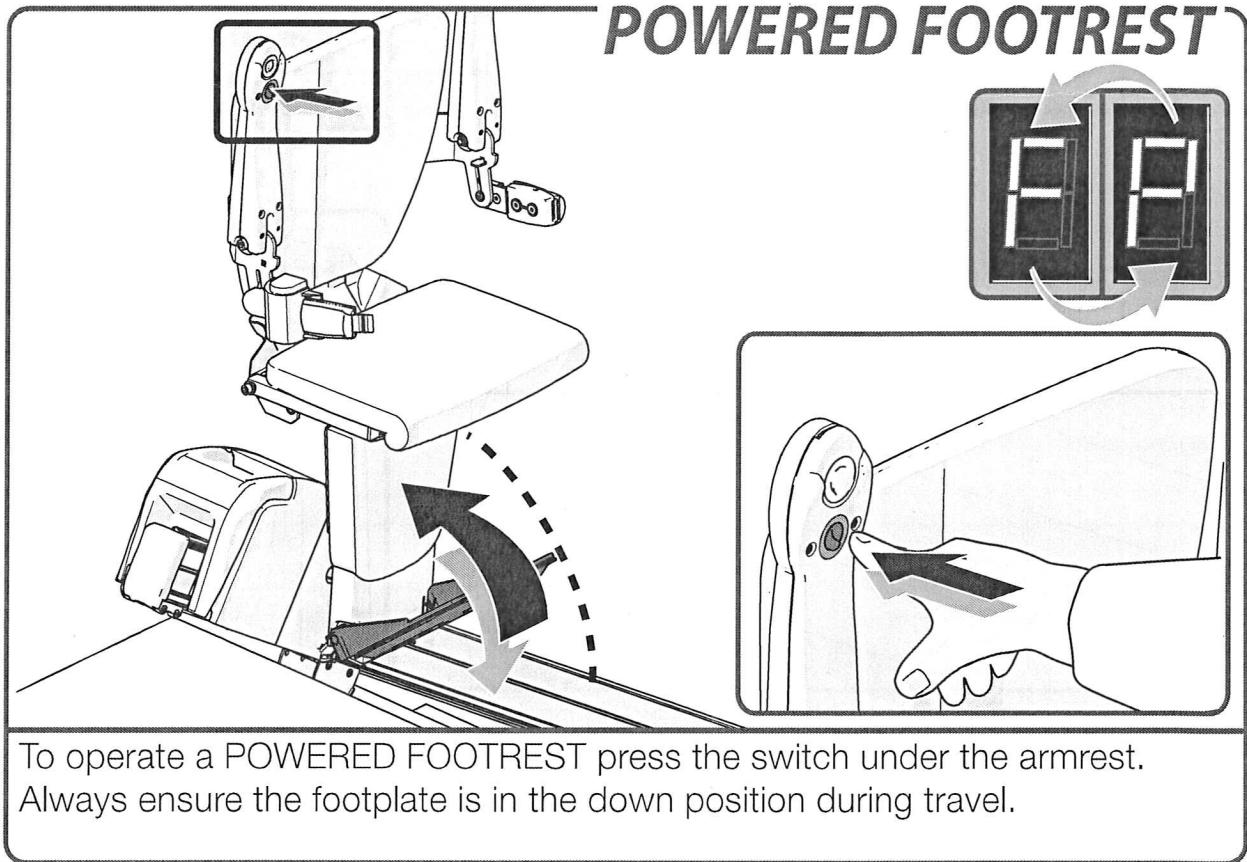

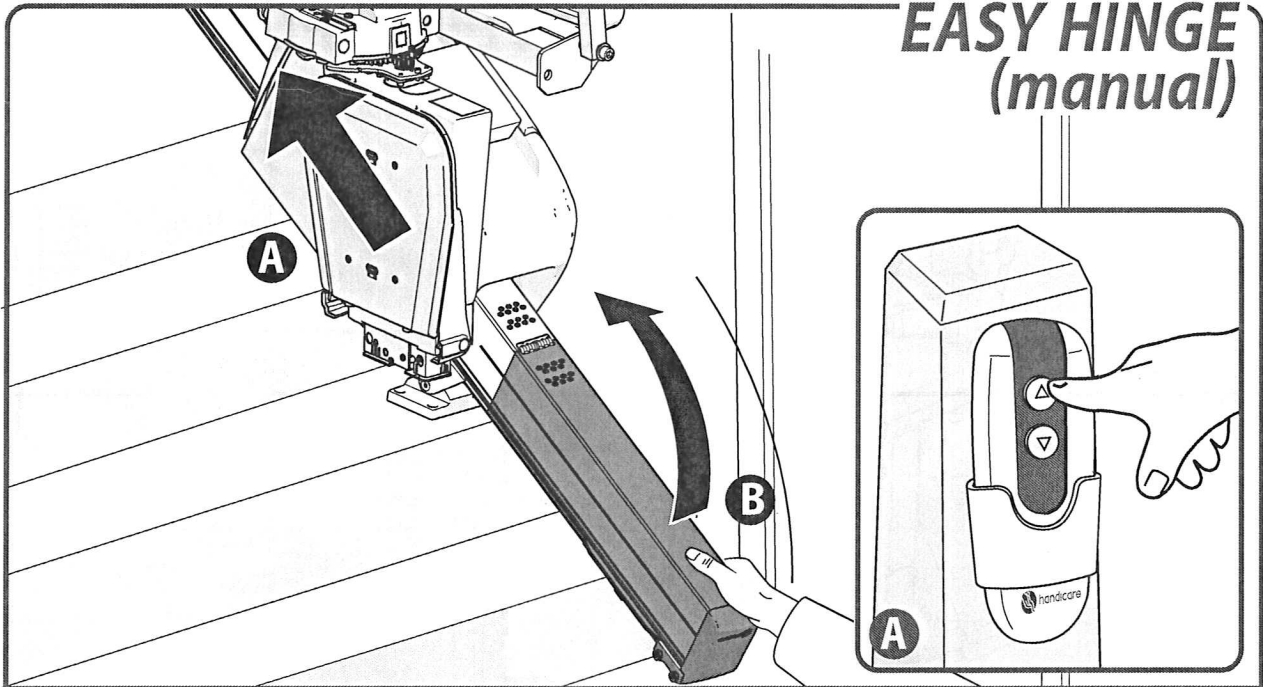

Before raising the manual hinged track{B} park the stairlift above the hinge, or at the top of the stairs{A}. When your stairlift is not in use it should always be positioned away from the hinged section with the hinge in the raised position.

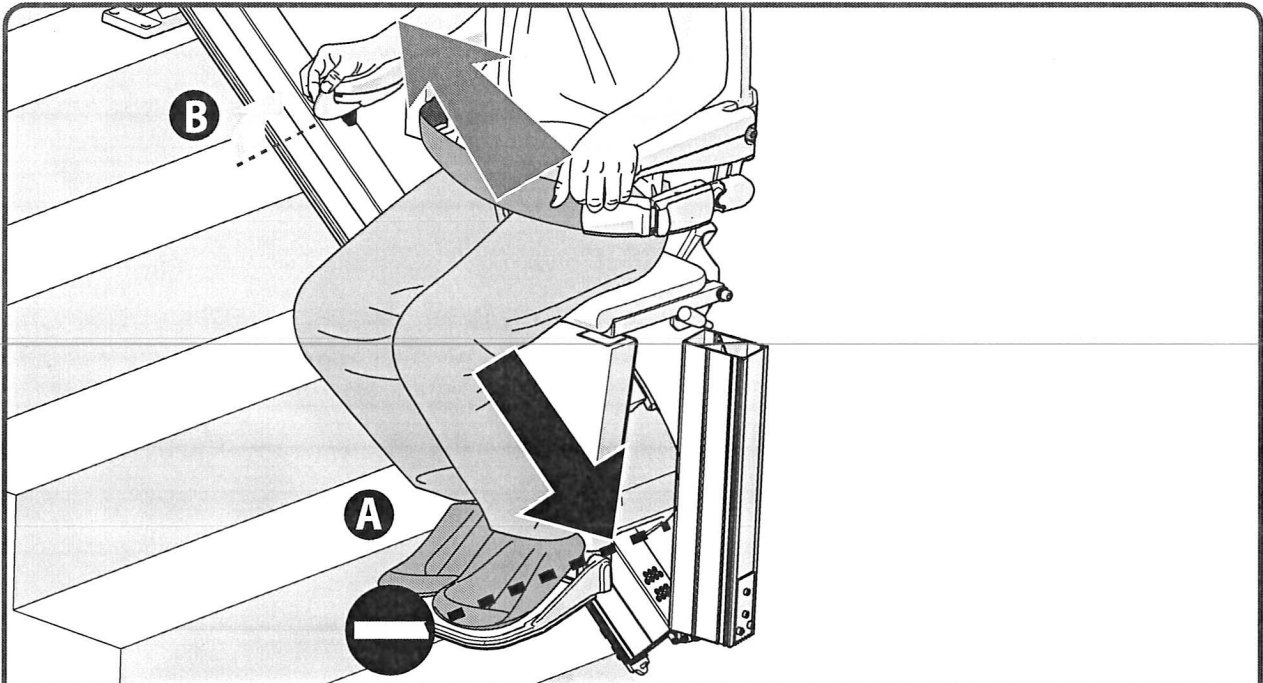

When the lift moves against a folded hinge it will stop automatically{A}. The lift can still ride in the upwards direction{B}.

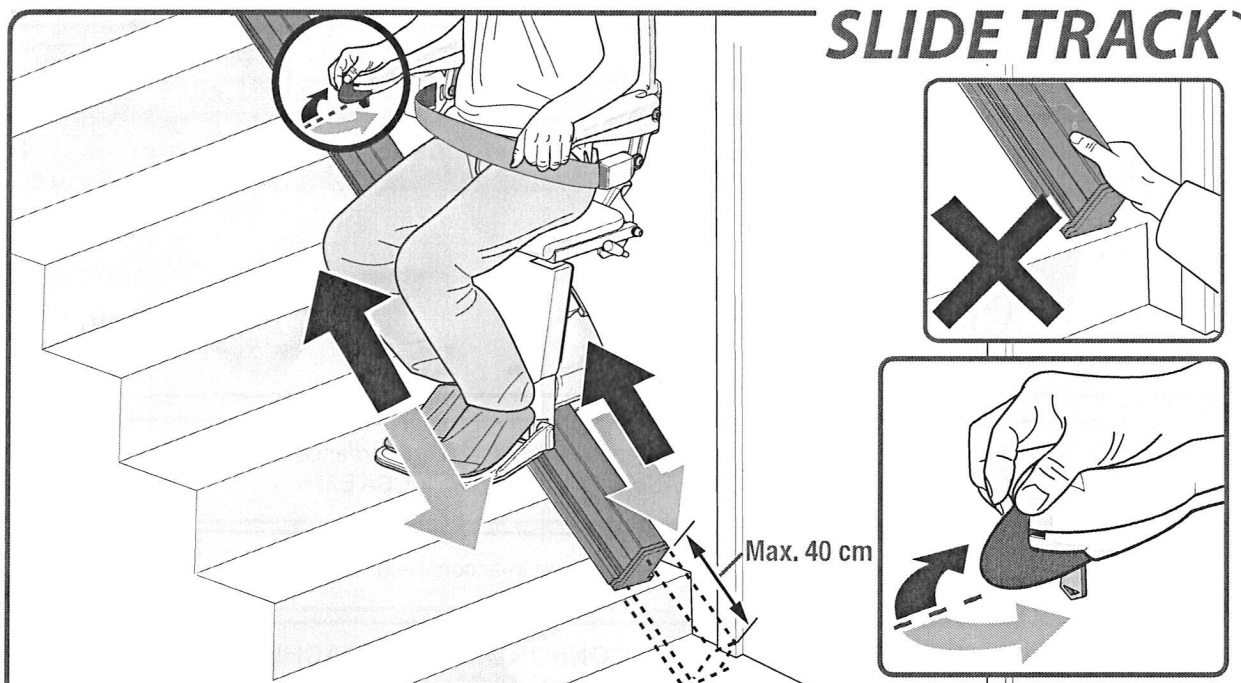

If the lift has a sliding track, both the chair and slide track will move at the same time. Once the slide track has reached the end of its travel the lift will continue its travel. Keep the toggle pressed in the same direction.

In the case of a powered swivel: If the lift has reached the end of its travel at the top of the stairs and does not automatically swivel, the user should release the toggle and then press the toggle again to swivel the seat.

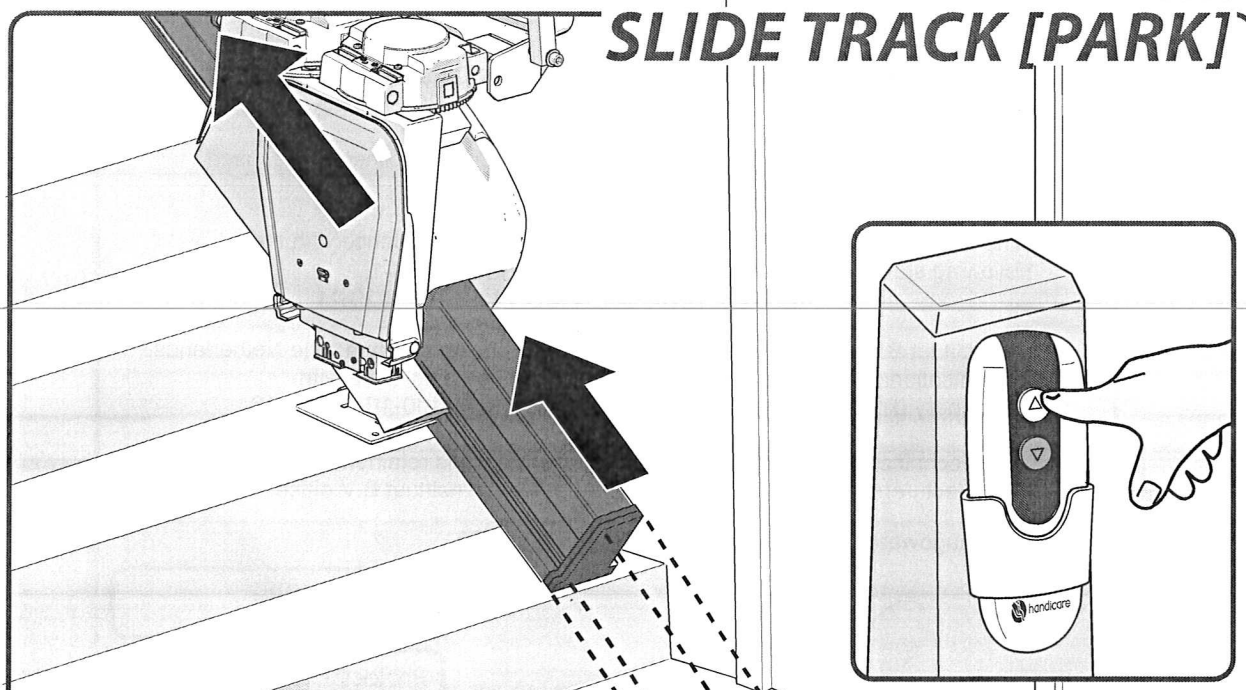

When the lift is not in use it should be moved away from the bottom of the stairs so that it does not cause an obstruction. To park the lift, press and hold the UP button on the handset.

## IMPORTANT INFORMATION



This lift is intended to be installed, serviced and used in accordance with the current edition of: ASME A18.1; ASME 17.5; CSA B44.1, CSA B355

The lift has been designed and manufactured in accordance with IEC 60601-1-2

### EC DECLARATION OF CONFORMITY FOR MACHINERY

(Directive 2006/42/EC)

Manufacturer: Handicare  
 Address : Newtonstraat 35  
 1704 SB Heerhugowaard  
 Postbus 39  
 1700 AA Heerhugowaard  
 Holland  
 Tel.nr. +31 (0)72-5768888

Herewith declares that the **Handicare 1100**

is in conformity with the provisions of the Machinery Directive 2006/42/EC, Low Voltage Directive 2014/35/EU and EMC Directive 2014/30/EU.

The stairlifts are 24V DC Powered Stairlifts moving in an inclined plane, used with an approved battery charger product.

The stairlift has been designed and manufactured in accordance with the following standards: EN 81-40, ISO 9386-2, EN ISO 12100-1, EN ISO 12100-2, EN ISO 14121, EN60204-1

Liftinstituut B.V., Buikslotermeerplein 361, 1025 XE, Amsterdam, The Netherlands. Identificationnr 0400 has issued an EC-certificate in compliance with machinery directive 2006/42/EC with reference NL17-400-1001-015-10.

The Technical Construction File for the above Stairlift is retained at the manufacturers address. A copy is retained at the Liftinstituut B.V.office.

Heerhugowaard, The Netherlands, 21 February 2020

J. Hopman  
 Managing director Handicare stairlifts HHW

Serial no. unit:

Project:

Date:

## FOREWORD

Your Handicare 1100 stairlift is a sophisticated product for indoor use only that has been specifically developed to carry one person sitting on the seat. Before using your Handicare 1100 stairlift please read this manual thoroughly to familiarise yourself with how to operate your stairlift. Your stairlift has been constructed with state of the art technology and in accordance with recognised safety regulations so you can be sure that you have a safe and reliable solution.

Nevertheless, incorrect use of the stairlift may cause risk to the user or third parties, damage to your stairlift or other goods. Use your stairlift only when it is in good working order, in accordance with the intended use described above and with due attention to this manual. Always keep this manual near the stairlift.

## TECHNICAL SUPPORT

Should issues arise that are not covered by this document please contact your supplier. Their Service department staff will always be pleased to help you. To help them identify your product please have the following details to hand when you call them:

- this manual
- your name, address, postcode, town and telephone number  
stairlift serial number which can be found on the label located on the power pack underneath the seat.

## SAFETY INSTRUCTIONS

When using the stairlift always observe appropriate safety regulations regarding risk of electric shock and physical injury.

1. Provide an unobstructed environment by ensuring that the entire track is free of obstacles. Keep the rail free from oil and ice.
2. Take environmental influences into account. Do not expose the lift to damp or extreme sunlight. Make sure that the environment is well lit.
3. The stairlift should only be used by individuals who have received the appropriate guidance. On installation the supplier is required to demonstrate how to use this stairlift and the user is required to sign the declaration confirming that this instruction has been received.
4. Stairlifts should only be used for carrying one person: do not use your stairlift to carry pets, goods or more than one person at a time, even if the load is below the maximum user weight. Keep children and pets away from the stairlift.
5. Remove the key after use to prevent unauthorised use.
6. Keep limbs and clothing away from moving parts. Make sure that wide or loose clothing cannot become trapped between the chair and the stairs or rail.
7. Ensure a safe position during use. Always ensure a correct, stable position. Please sit as far back in the seat as you can and place your feet as close to the centre of the footplate as you are able to. Always use the safety belt and never stand on the stairlift.
8. Take care at all times. Concentrate on the operation of the stairlift as releasing the operating toggle will cause the lift to stop. To restart the lift wait 3 seconds and push and hold the toggle in the direction of travel desired until you reach the landing

or hallway.

9. Check for damage. Before use check the lift for external damage. Report unusual noises, such as squeaking and creaking, to your supplier. To avoid accidents repairs and preventive maintenance should only be carried out by engineers qualified to do so.
10. The stairlift must not be used in the event of a fire or as a means of escape during a fire.
11. If the stairlift is not fitted with a communication device, we recommend that you always have one to hand.

### **Structure**

The strength and the suitability in general of wall, staircases, terraces, upper floors, banisters, plinths etc. which are to support or surround the installation have been verified and ensured by the customer, who therefore accepts all relative responsibilities. Neither Handicare nor its authorised dealers may be held responsible for the suitability of the structures which surround and support the installation.

## **MAINTENANCE**

### **Cleaning**

Clean the stairlift regularly with a damp cloth; avoid excessive use of water. Clean the rail regularly with a vacuum cleaner with a soft brush. Ensure the track is kept free of dirt and dust. Any dirt on the rail can easily be removed with a slightly damp cloth. Under no circumstances should you use cleaning product when cleaning the rail. The use of lubricant on the rail is also not permitted. After a while, the wheels may leave marks on the rails.

### **Preventive maintenance**

In addition to cleaning your stairlift, periodic preventive maintenance is necessary for continued long-term use.

Your stairlift must be serviced at least once a year by a qualified person. If your stairlift has more than two users we recommend a minimum of two services per year.

Please make an electrical socket available to provide local lighting if required during inspection and servicing. Lighting to a minimum value of 50 lux shall be provided at the boarding points whilst the stairlift is in use. Most light bulb packaging will detail the lux value of the light bulb.

## **GUARANTEE AND LIABILITY**

The manufacturer guarantees that this stairlift (excluding batteries) will be repaired free of charge should manufacturing and/or material defects occur within 24 months of the purchase date, during normal use in accordance with the recommended user, installation and maintenance instructions. Damage caused by normal wear and tear, overloading or misuse and the replacement of batteries in the remote control is not covered by this guarantee.

We recommend that your stairlift is serviced annually by an appropriately qualified stairlift engineer.

Under no circumstances can the manufacturer accept responsibility for death, personal injury, damage to property, or incidental, unforeseen consequences and/or costs or damage resulting from the use of your stairlift.

The carrying out of alterations to the product is not permitted and doing so will invalidate the warranty. The manufacturer is not liable for damage resulting from such alterations. The manufacturer accepts no liability for damage or injury caused by the non or inadequate observance of the safety regulations and instructions in this manual, or by negligence during the installation, use, maintenance and repair of this stairlift. Installation and servicing should only be carried out by dealers or installers/service engineers authorised by the manufacturer in accordance with local regulations. The wall mounted remote controls operate on a infrared frequency; Handicare is unable to accept responsibility for system inoperability in the unlikely event of interference from signals external to this stairlift.

## TECHNICAL SPECIFICATIONS

Supply voltage	100-240 V~	Speed	max. 0.15 m/s
Frequency	50/60 Hz	Ambient temperature	0 - 40 °C
Current	1.0 A	Relative humidity	20 - 80%
Power consumption	0-36 watt	Usage	10 rides per day
Fuses	20 A	Noise	56 dB
Max.load (inclination 30°-45°)	140 kg	Use	Indoor
Max.load (inclination 45°-50°)	130 kg		
Max.load (SlideTrack)	120 kg		

## TECHNICAL SPECIFICATIONS NA

Supply voltage	120 V~	Speed	max. 0.49 f/s
Frequency	60 Hz	Ambient temperature	32 - 104 °F
Current	0.83 A	Relative humidity	20 - 80%
Power consumption	20 watt	Usage	10 rides per day
Fuses	20 A	Noise	56 dB
Max.load (inclination 30°-45°)	308 lbs	Use	Indoor
Max.load (inclination 45°-50°)	286 lbs		
Max.load (SlideTrack)	264 lbs		

The information provided in this manual is based on general specifications regarding the construction, material properties and working methods known to us at the time of publication; alterations and improvements are therefore anticipated.

*All rights reserved. No part of this publication may be reproduced and/or published by means of print, photocopy, microfilm or in any other way or form, without prior written permission from the manufacturer. This also applies for the accompanying drawings and diagrams. The manufacturer reserves the right to change parts at any time, without prior or direct notification to the customer. The contents of this manual may also be changed without prior warning. This manual is intended for the standard models of the lift. The manufacturer therefore cannot be held liable for any damage resulting from specifications that differ from those of the standard model of the lift supplied to you. For information concerning adjustment, maintenance or repairs not provided in this manual, please contact your supplier's service department. This manual has been compiled with the best intentions and every possible care but the manufacturer cannot accept responsibility for any errors in this manual or for the consequences thereof.*

*The Dutch manual is the original language.*

## FAULTFINDING

<b>DIAGNOSTIC DISPLAY</b>	page 18
<b>KEY</b>	page 19
<b>EMERGENCY STOP</b>	page 19
<b>ARMREST</b>	page 20
<b>CHAIR POSITION</b>	page 20
<b>BATTERIES</b>	page 21
<b>POWER</b>	page 21
<b>OBSTACLE</b>	page 22
<b>LOW POWER</b>	page 22

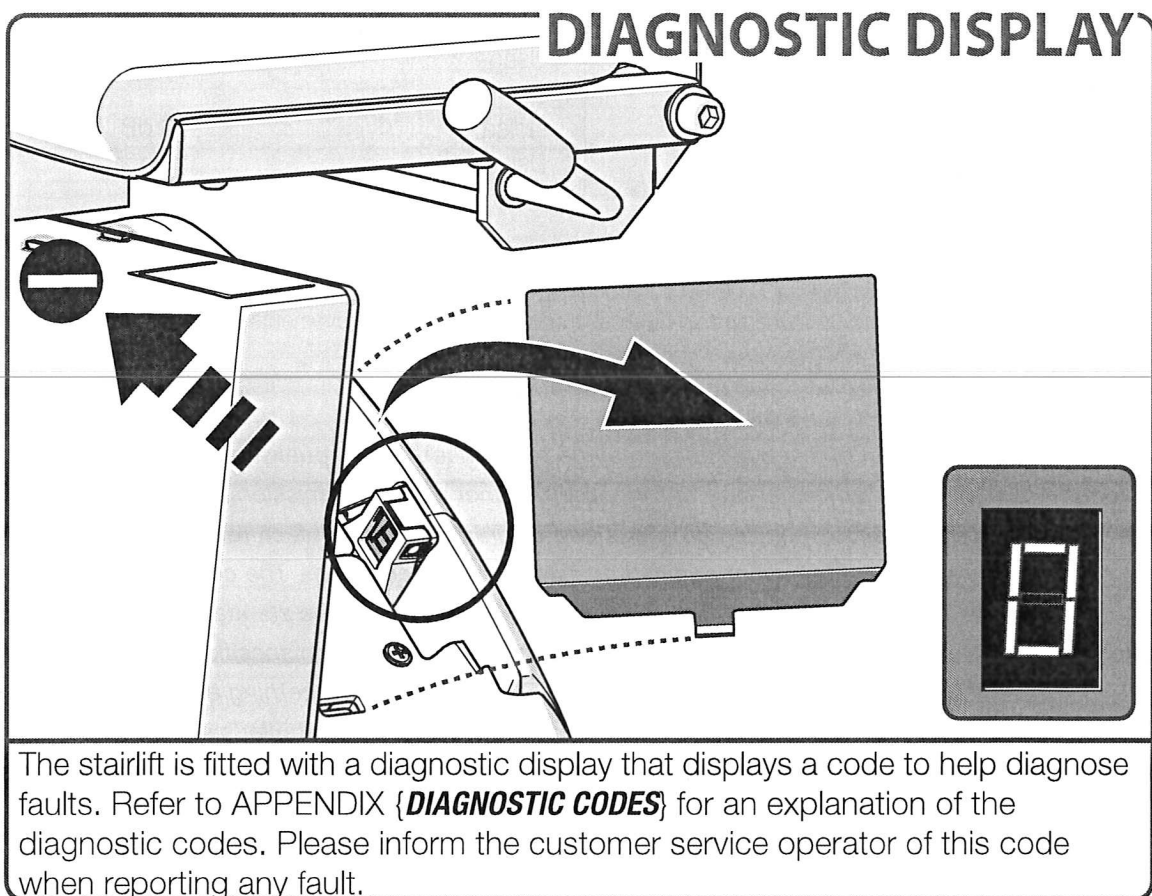

**KEY**

**CAUSE**

**SOLUTION**

**Problem:** the lift does not travel in either direction and the display shows a "0".

**Cause:** the key-operated switch is in the off position.

**Solution:** turn the key-operated switch ninety degrees clockwise.

**STOP BUTTON**

**CAUSE**

**SOLUTION**

**Problem:** the lift does not travel in either direction, the display shows a "0" [1] and the stop button [2] is illuminated.

**Cause:** the stop button has been pressed.

**Solution:** press the stop button once.

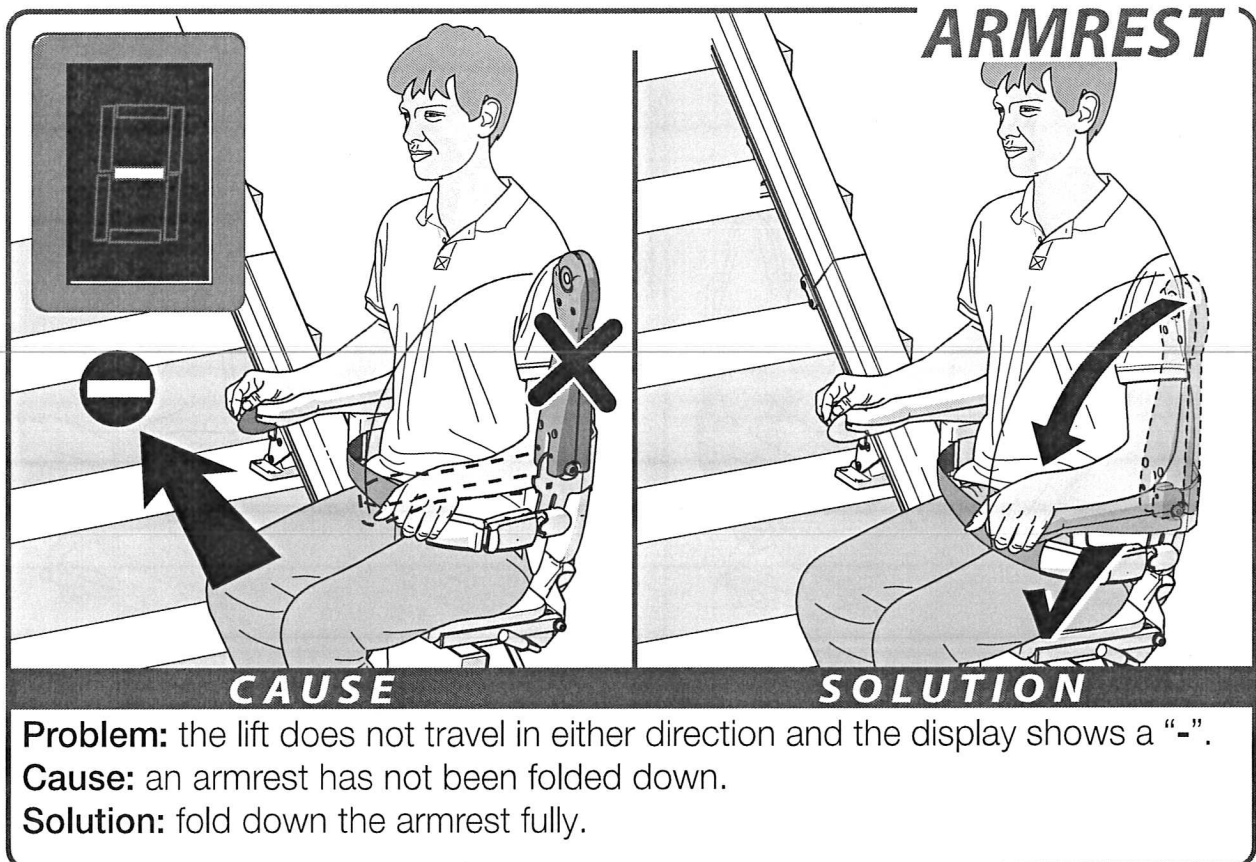
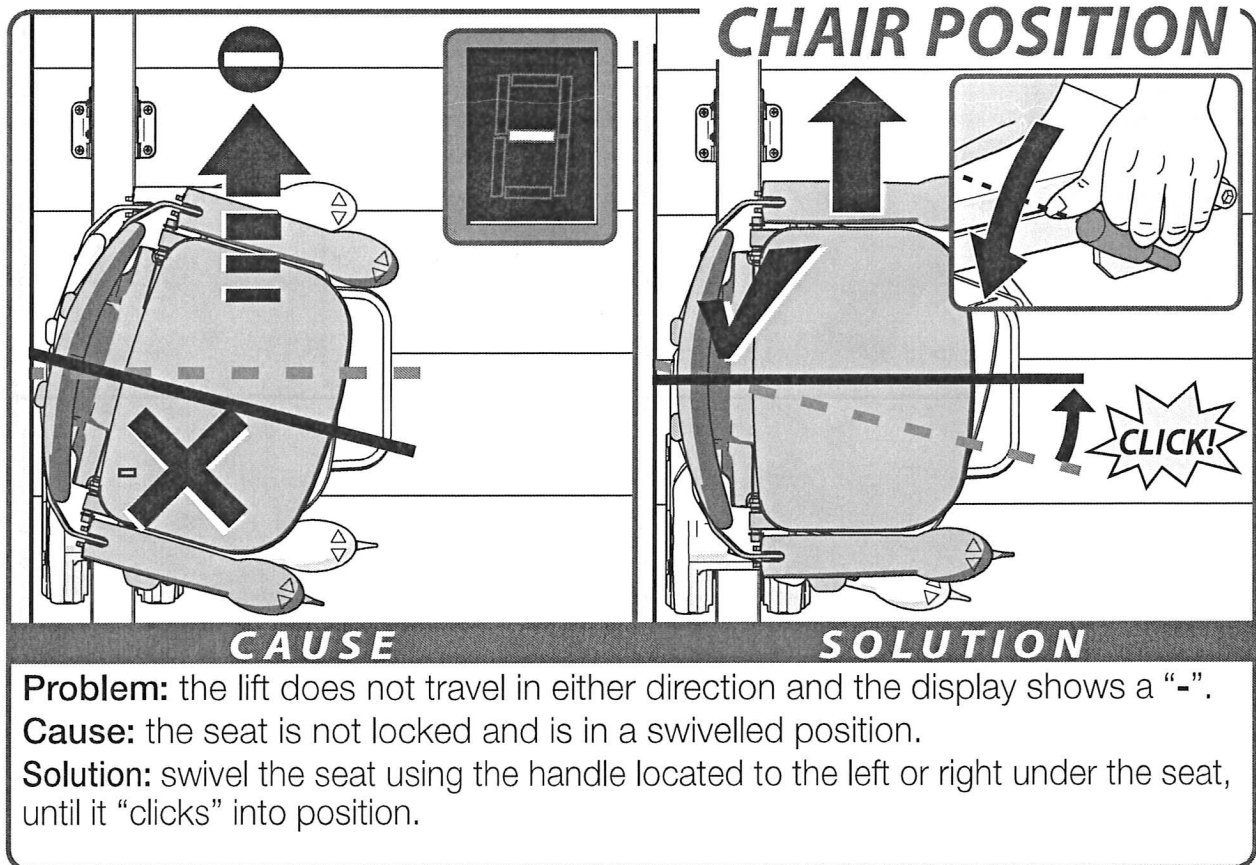

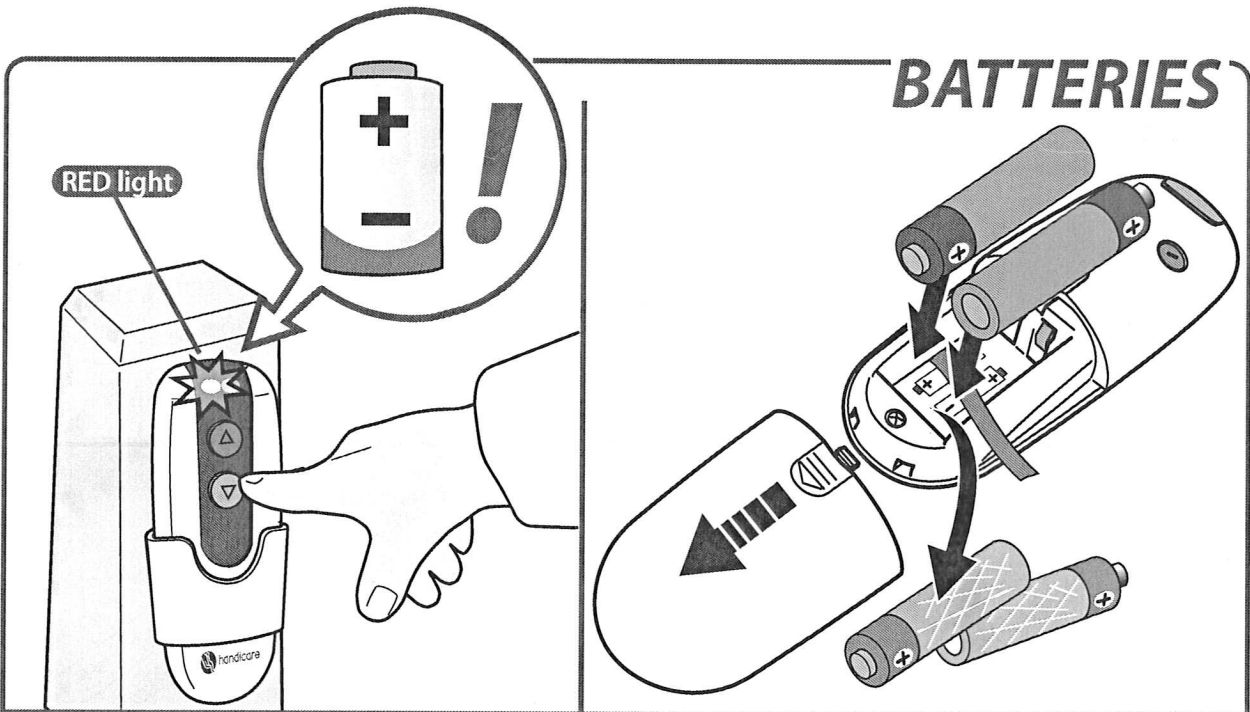

# BATTERIES

## CAUSE

## SOLUTION

**Problem:** the lift does not travel in either direction and the Light on the remote control shines red when the remote control is operated.  
**Cause:** the batteries in the remote control are flat.  
**Solution:** replace the batteries in the remote control.

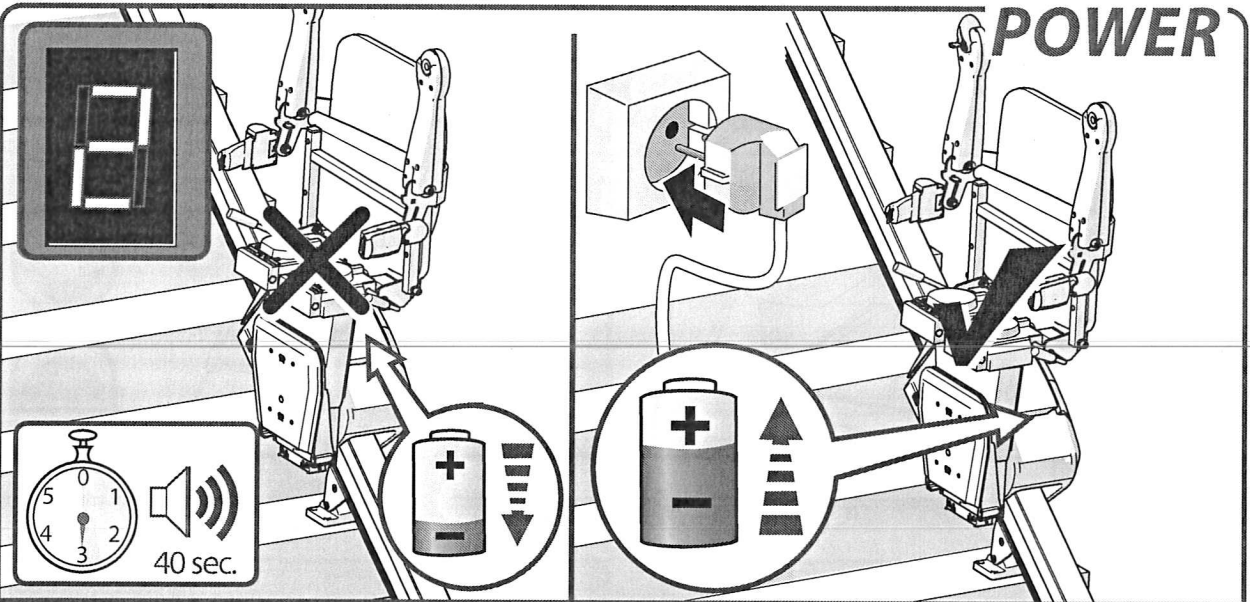

# POWER

## CAUSE

## SOLUTION

**Problem:** the lift beeps for 40 seconds and the display shows a "2".  
**Cause:** the lift batteries are not recharging, possibly the plug is not in the socket.  
**Solution:** put the plug in the socket.

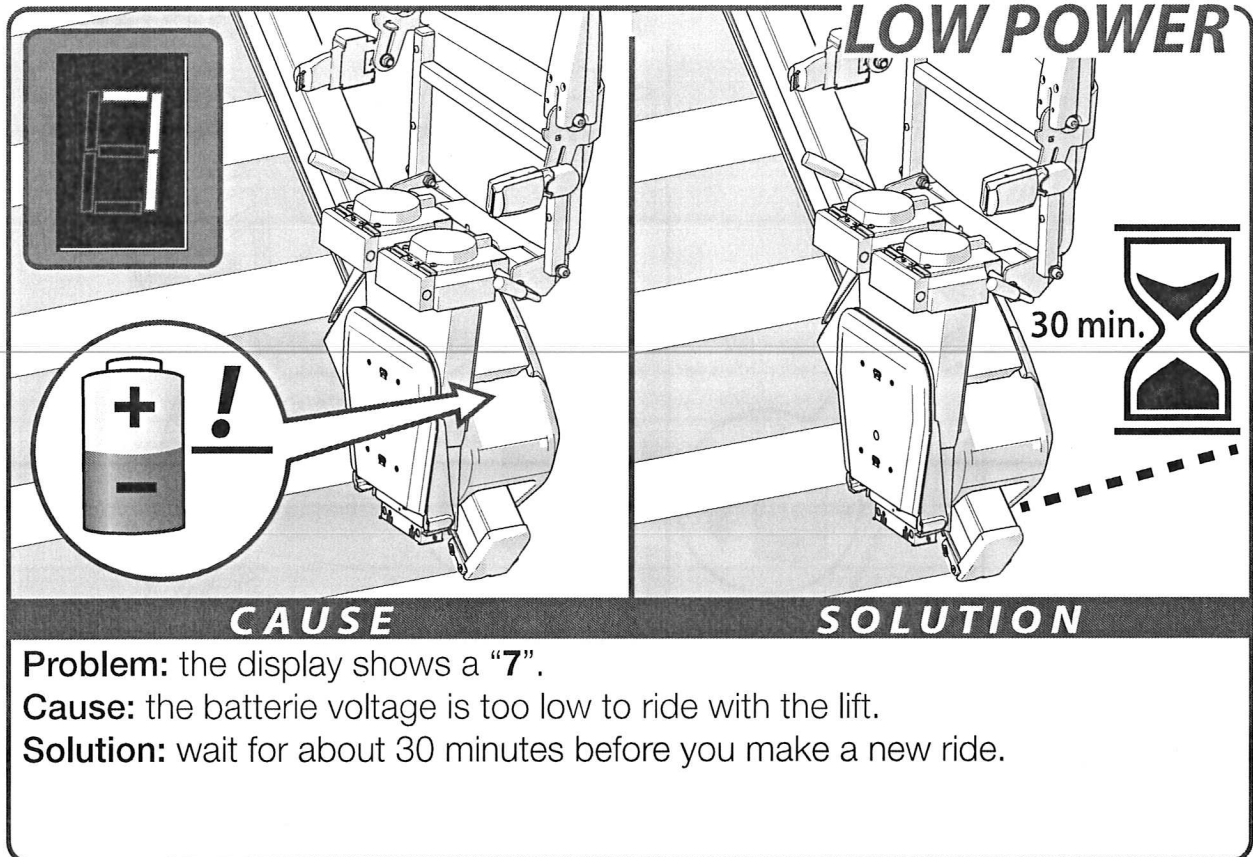
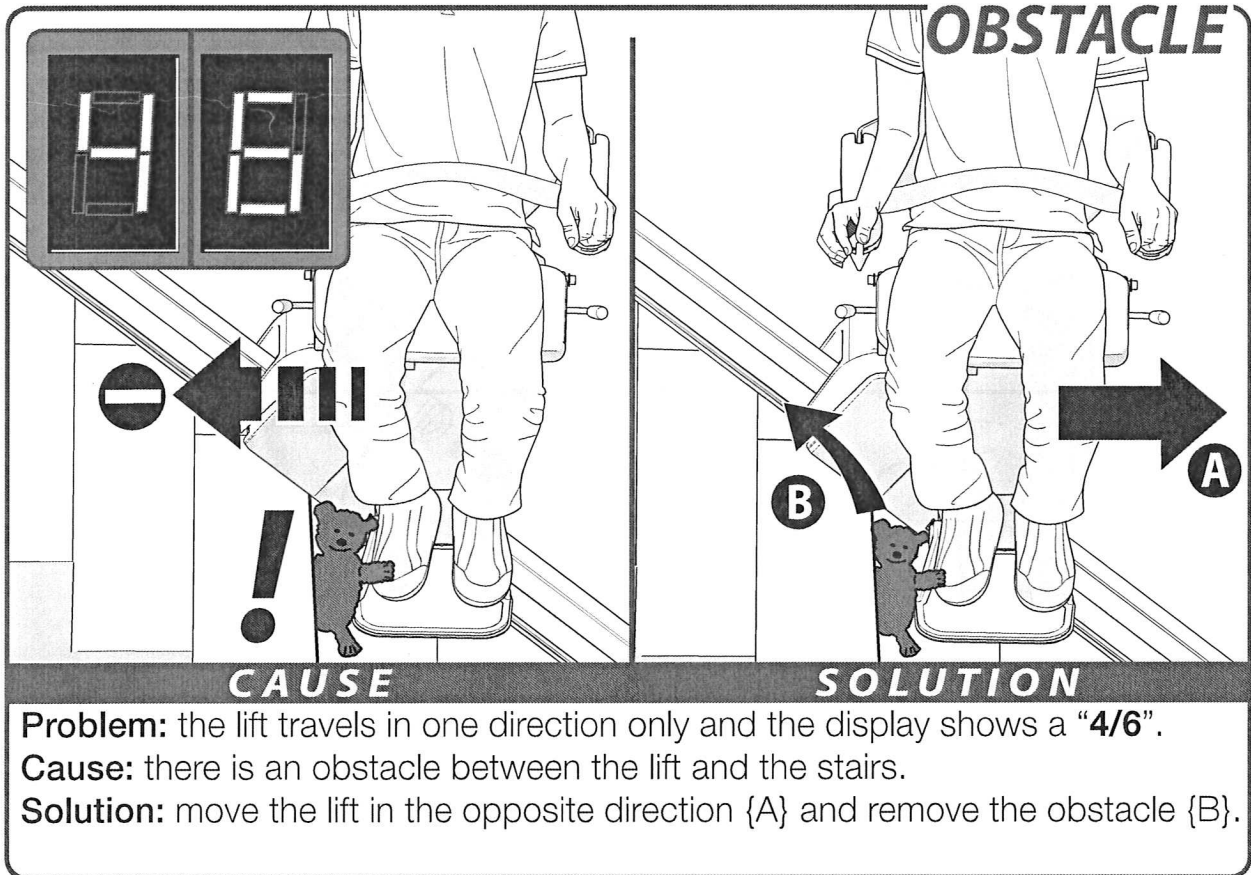

## ATTACHMENTS

**REMINDERS** \_\_\_\_\_ page 23

**EMERGENCY OPERATIONS** \_\_\_\_\_ page 24

**DIAGNOSTIC CODES** \_\_\_\_\_ page 26

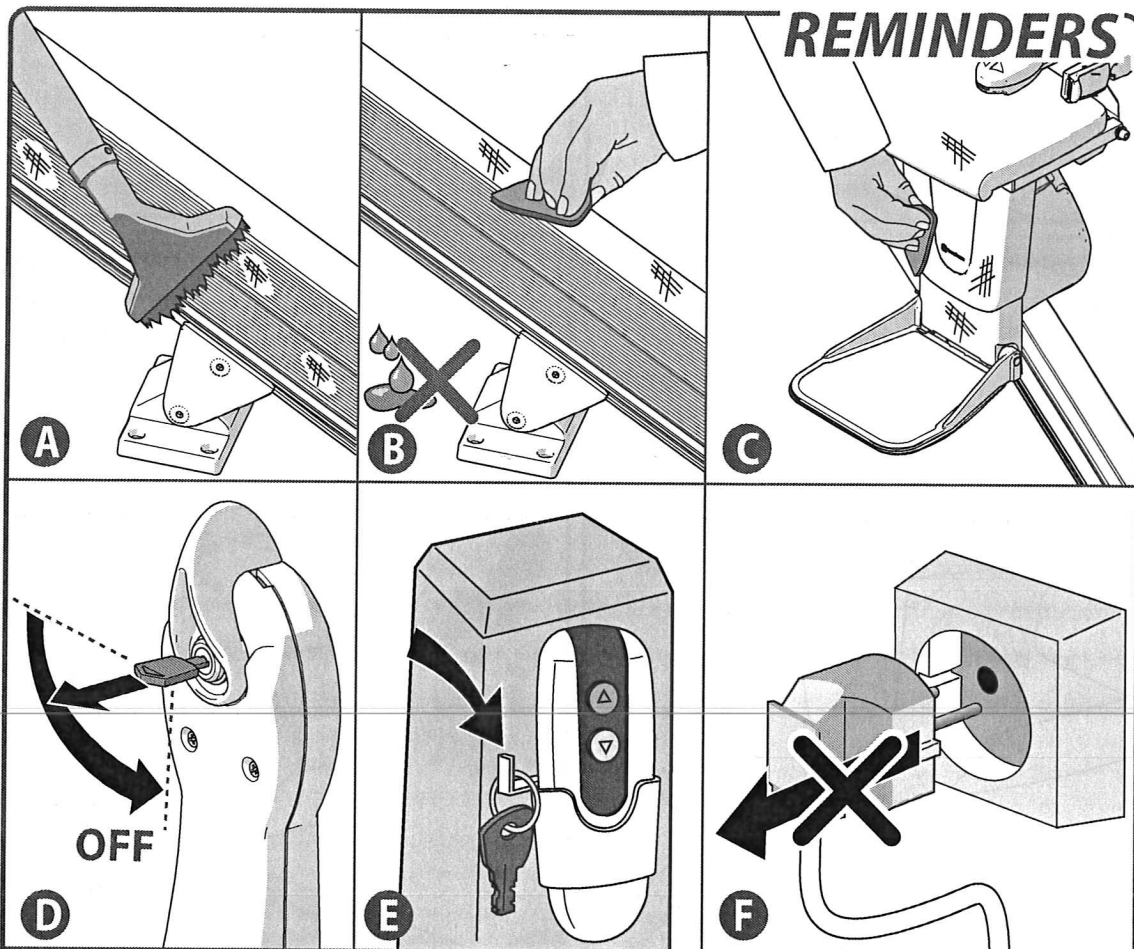

- [A] Clean the rail regularly with a vacuum cleaner with a soft brush.  
 [B] Any dirt on the rail can easily be removed with a slightly damp cloth. Under no circumstances should you use cleaning product when cleaning the rail.  
 [C] Clean the stairlift regularly with a damp cloth.  
 [D] Remove the key from the switch whenever you leave the lift.  
 [E] It is recommended that the keys be stored close to the stairlift by hanging a key on the handset wall bracket.  
 [F] Never remove the lift plug from the wall socket.

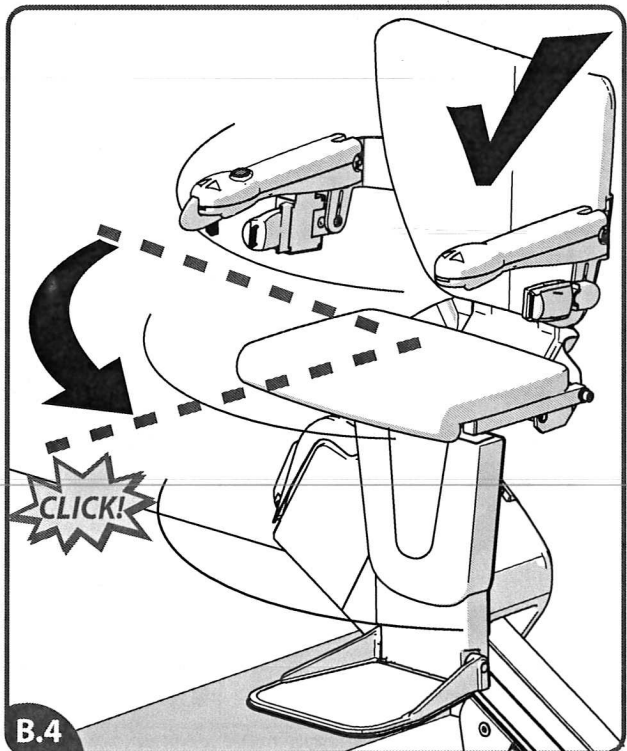
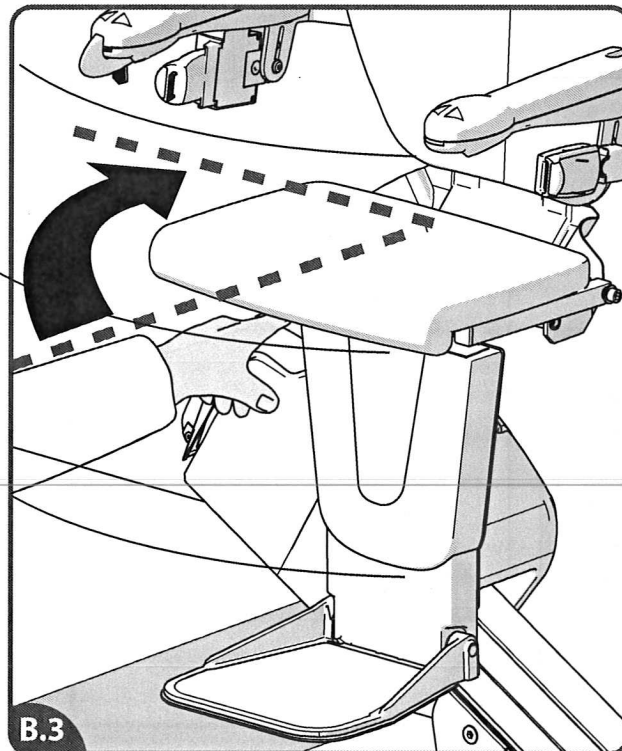
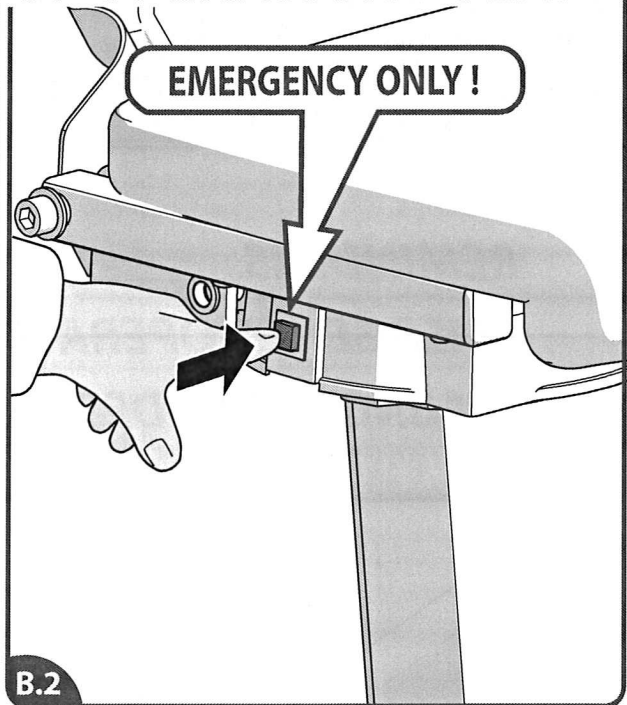
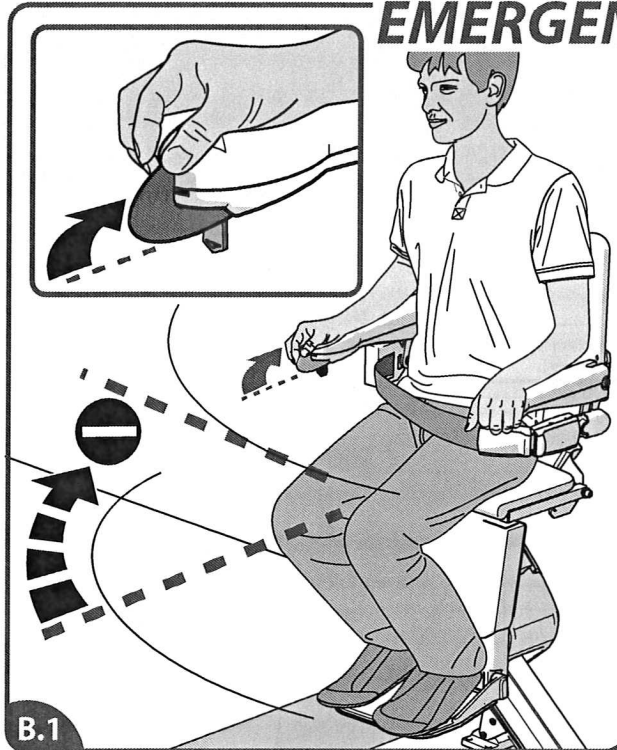
**EMERGENCY OPERATION > SEAT**

[B.1] If the powered swivel is not functioning it can be swivelled manually. Do this only in an emergency. [B.2] Press the release button. [B.3] Swivel the seat manually. [B.4] The seat must be returned to the start position. Do this before you use the lift again.

# SLIDE TRACK EMERGENCY MANUAL OVERRIDE

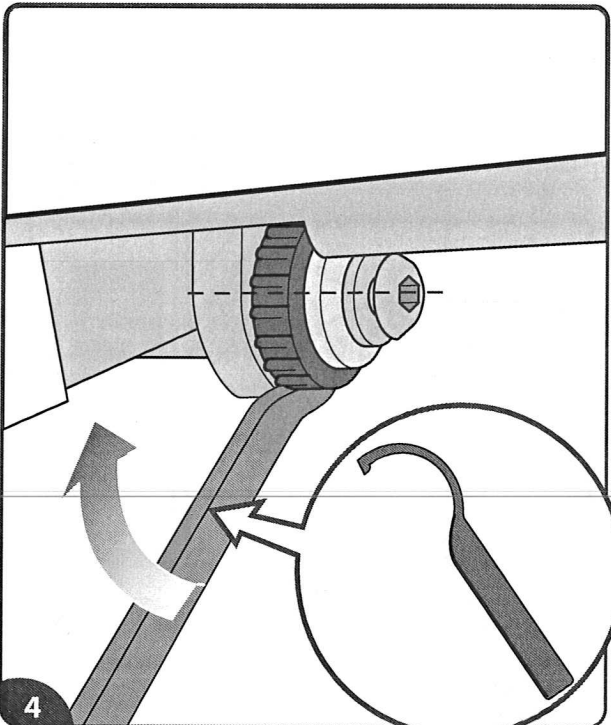
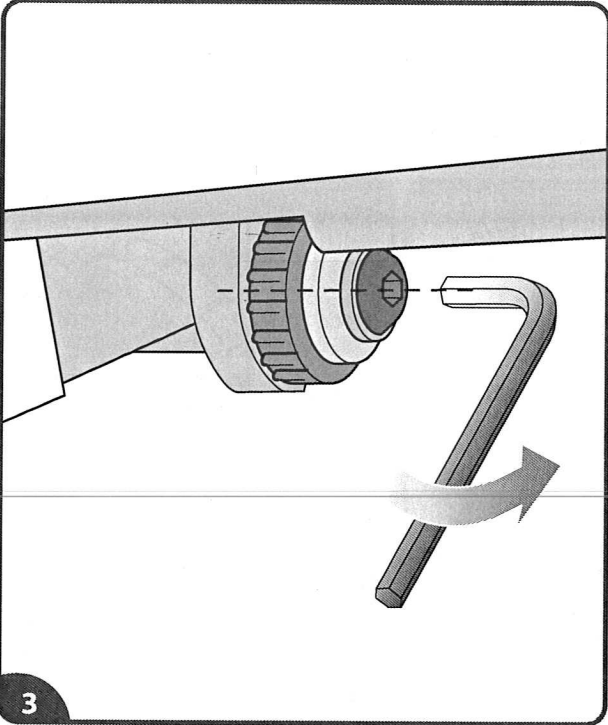
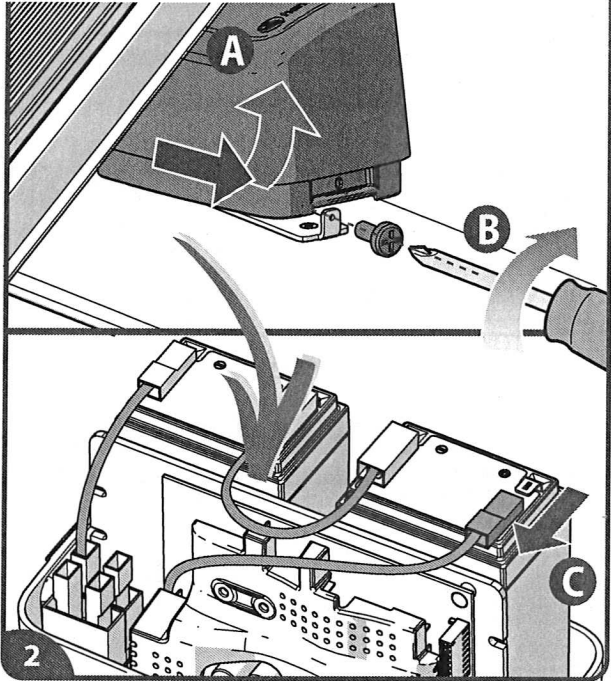
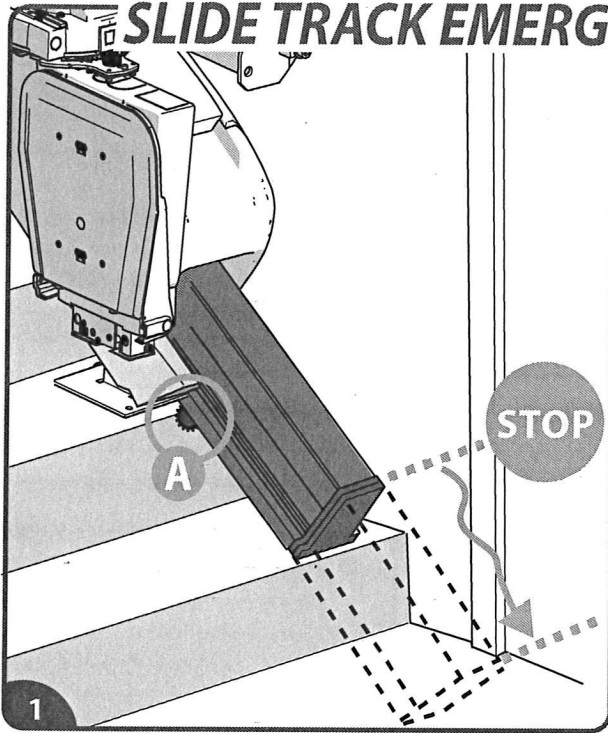

The Slide Track is also fitted with an emergency manual override positioned towards the bottom of the track. This allows a trained person to manually move the track using the supplied special spanner. [1] The Slide Track manual override is positioned towards the bottom of the track (A). [2] Disconnect the battery to remove all power from the battery box. [3] To move the Slide Track manually you must first loosen the locking bolt. [4] Use the spanner supplied as shown in (Figure 4) to move the Slide Track.

If the mentioned action does not help, call Handicare.

## DIAGNOSTIC CODES

Write down the diagnostic code when you call Handicare for help.

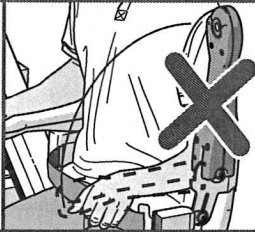
Display	Action
	
Charging, but the lift does not drive. Possibly the armrest is folded.	
<b>FAULT</b>	

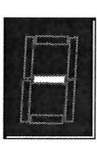
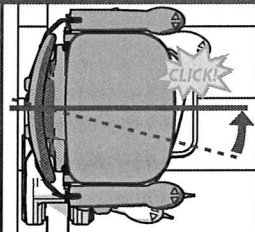
Display	Action
	
Chair in swivel position	
<b>FAULT</b>	

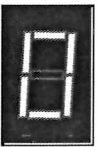
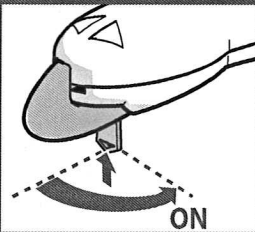
Display	Action
	
Key switch off	
<b>FAULT</b>	

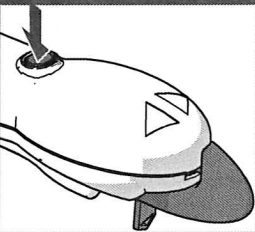
Display	Action
	
Stop button activated	
<b>FAULT</b>	

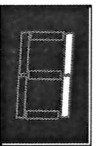
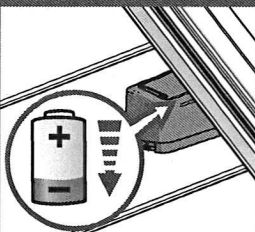
Display	Action
	
Requires charge	
<b>FAULT</b>	

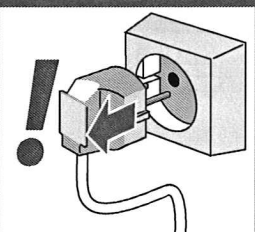
Display	Action
	
Off charge	
<b>FAULT</b>	

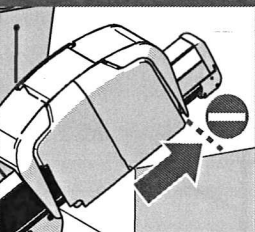
Display	Action
	
Top track limit activated	
<b>FAULT</b>	

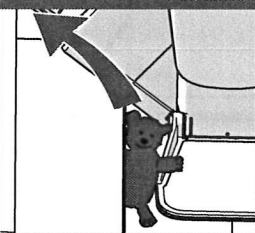
Display	Action
	
Top safety edge activated	
<b>FAULT</b>	

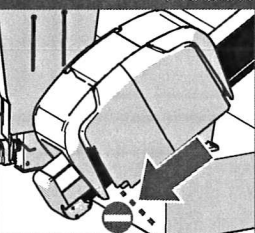
Display	Action
	
Bottom track limit activated	
<b>FAULT</b>	

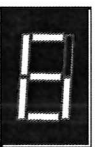
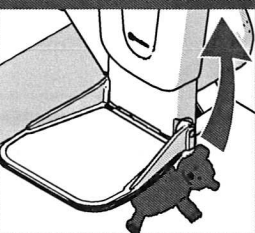
Display	Action
	
Bottom safety edge activated	
<b>FAULT</b>	

Display	Action
Low battery voltage	
<b>FAULT</b>	

Display	Action
Toggle activated: - the lift rides up	

Display	Action
Toggle activated: - the lift rides down	

Display	Action
The main power relay not open	
<b>FAULT</b>	

Display	Action
Motor problems [L0=n, L1=n, L2=n, L3=n, L4=n]	
<b>FAULT</b>	

Display	Action
The main control board has a memory problem	
<b>FAULT</b>	

Display	Action
Use toggle to undo Sleeping mode	
<b>FAULT</b>	



Display	Action
Use button remote control to undo Sleeping mode	
<b>FAULT</b>	



Display	Action
Toggle delay: self test lift	
<b>FAULT</b>	

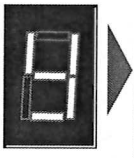

Display	Action
Infrared remote control registered	

Display	Action
Radio frequency remote control registered	

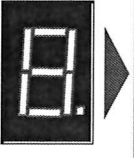
Display	Action
Footplate activated	

Display	Action
	
Hardware fault [Y0, YF, YI, Yr, Yb, YbF]	
<b>FAULT</b>	

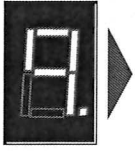
Display	Action
	
Toggle activated: - swivel up	

Display	Action
	
Toggle activated: - swivel down	

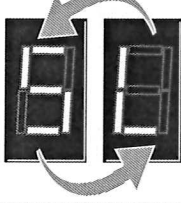
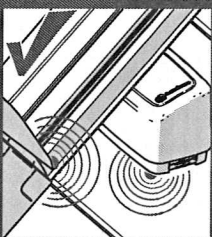
Display	Action
	
Slide Track registered	

Display	Action
	
No Slide Track registered	